



June  
25 Cents

# Radio-Craft

for the  
Professional-Serviceman-Radiotrician

HUGO GERNSBACK Editor

## IN THIS ISSUE

Articles by  
L. M. COCKADAY  
SYLVAN HARRIS  
JOHN F. RIDER  
DAVID GRIMES  
And Many Others

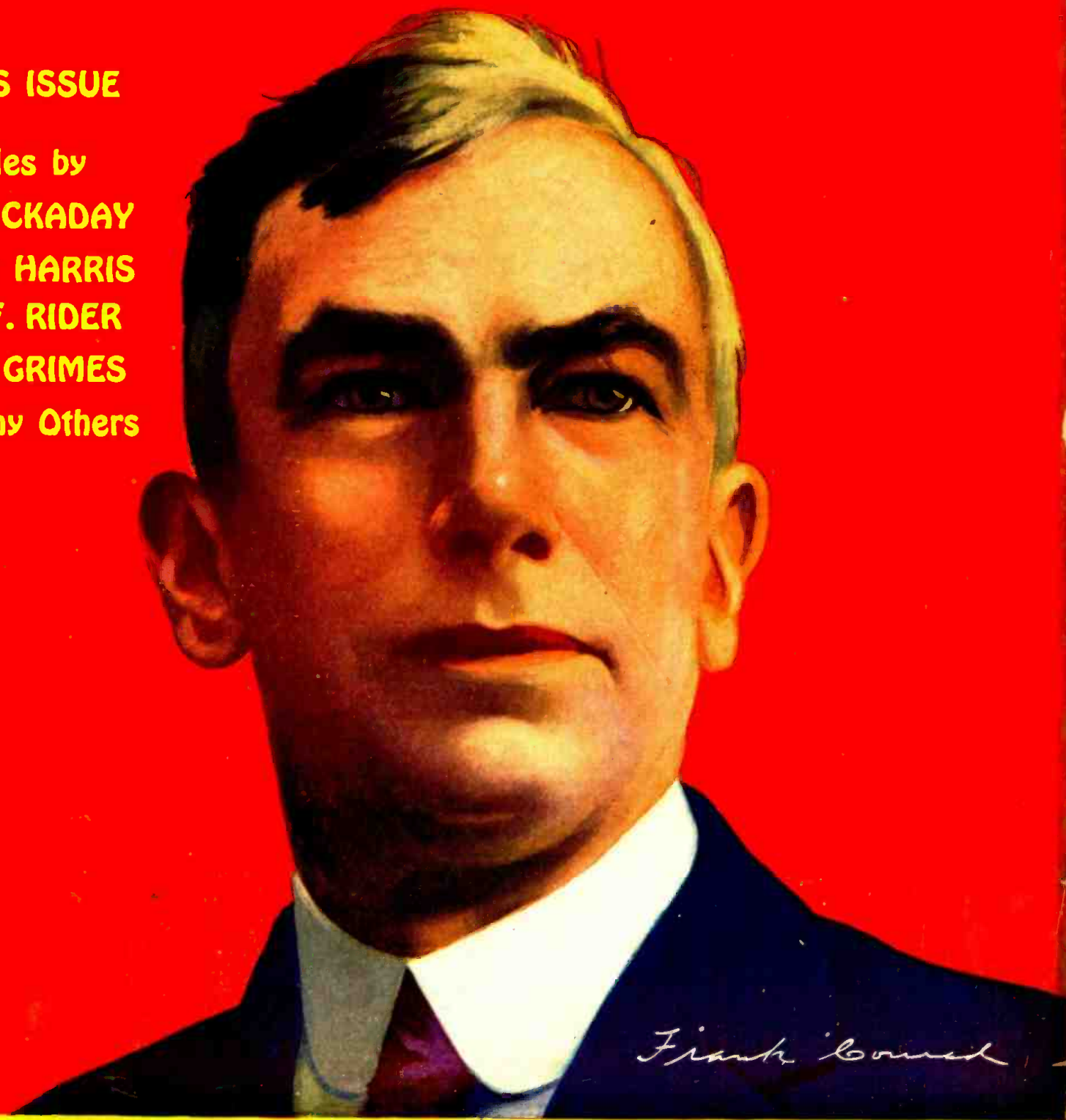

*Frank Conrad*

**Men who have made Radio** **Frank Conrad**



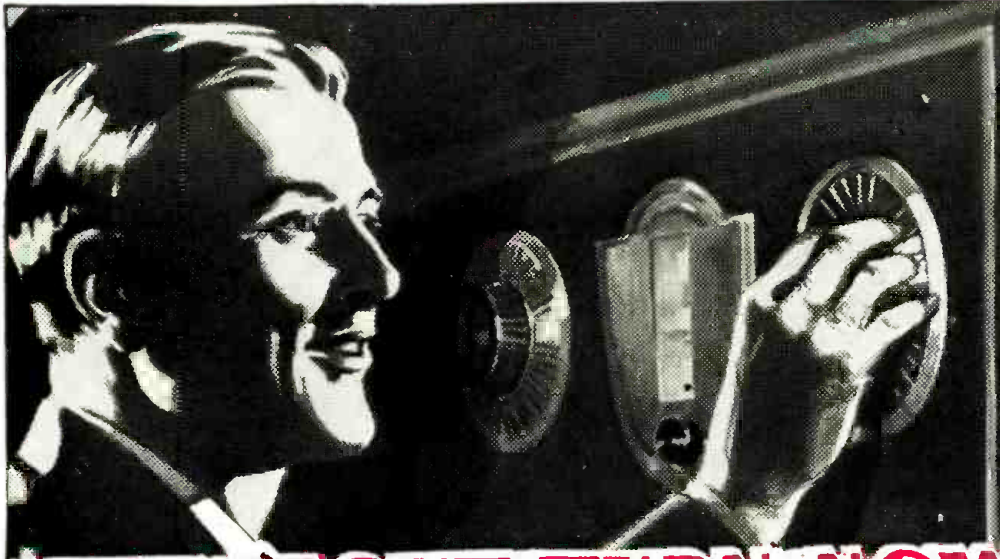

# THE RIGHT TURN NOW BRINGS BIG-MONEY JOBS

and lifetime success in the newest and fastest growing industry in the world

## RADIO

The great new infant Radio industry continually outgrows the supply of trained men for its needs. Therefore, R. T. I. is seeking hundreds of earnest, ambitious men to train to fill the jobs that lead to \$2000—\$2500—\$3500 a year and up. Spare-time work too is waiting everywhere—thousands of dollars to be made easily, quickly, in every part of the country.

## TELEVISION

Now comes Television out of the experimental radio laboratory on the verge of another vast demand for men who are qualified to expand it and the R. T. I. "3 in 1" Home Training in Radio, Television and Talking Pictures offers you big opportunity in this magic new field.

## TALKING PICTURES

The vast sweep of Talking Pictures through the larger cities is about to cover the country, creating more and more jobs that must be filled by men with such training as R. T. I. gives

### R. T. I. Famous "3 in 1" Home Training Radio—Television—Talking Pictures

Qualifies you easily, quickly, and surely for Big-Pay Jobs in RADIO or either of its new and fast-growing sister industries—TELEVISION and the TALKING PICTURES. Your age or previous experience do not matter.

### NOW IS THE TIME!

Never before in the history of the civilized world has there been such opportunity for ambitious men. These great industries—the "Big 3"—offer Big-Money Jobs—money-making without limit—all available to men and boys who are far-seeing enough "to get in on the ground floor"—right now, —and R. T. I. makes it easy for you to get in. Send for the Big free R. T. I. book.



F. H. SCHNELL

### Let F. H. Schnell and the R. T. I. Advisory Board Help You

Mr. Schnell, Chief of the R. T. I. Staff, is one of the ablest and best known radio men in America. He has twenty years of Radio experience. He was the first to establish two way amateur communication with Europe. Former Traffic Manager of American Radio Relay League, Lieutenant Commander of the U. S. Naval Reserve. Inventor and designer of Radio apparatus. Consultant Engineer to large Radio manufacturers.

Assisting him is the R. T. I. Advisory Board, composed of men prominent in the Radio industry—manufacturing, broadcasting, engineering and servicing. All these men know Radio and will help you succeed in their field.

## START AT HOME Quick Money NOW!

To meet the great demand for trained men from the new Radio, Television and Talking Picture field, R. T. I. with the help of its connections in the industry, has built up an easy, learn-at-home practical plan that will prepare you for these good jobs. You use fine testing and working outfits and learn by work sheets and the invaluable R. T. I. Job Tickets prepared by men who know. It's easy because clearly explained so you can do it—yet it is practical, scientific, and makes you an expert. R. T. I. starts you making money right at home and keeps stepping you up and up in the Big-Pay class.

### The Facts Will Thrill You

You cannot possibly imagine the astounding present development of Radio, Television and Talking Pictures—their limitless future expansion—the big number of money-making jobs—spare-time profits—right now and rushing on bigger and bigger. The actual pictures and facts from all sources all are in the R. T. I. Free Book.



#### RADIO FOREMEN

Large radio factory has opening for several foremen thoroughly experienced on chassis assembly lines. Will make interesting proposition to right men. ADDRESS—G V 138, Tribune

#### RADIO FINAL SET TESTER

Splendid opportunity for young man with thorough knowledge of radio, to handle final set test in production line. GALVEN MFG. CORP., 847 W. Harrison-st.

#### RADIO SERVICE MAN

Must be capable of servicing and installing any make of radio. Apply Mon. or Tues. between 9-11 a. m. 642 N. Michigan-av

#### RADIO TESTERS

and balances, experienced on A. C. sets; unusual pay for men who qualify. Call Smith, Groveshill 0600, or apply Silver-Marshall, Inc., 9401 W. 65th-st.



#### Salary Raised 33 1/3% Since Enrolling

Am now radio service manager for N. H. Knight Supply Co.—Earl P. Gordon, 618 E. 6th St., Oklahoma City, Okla.



#### Earned \$500 Extra in Two Months

In spare-time work — I give you all the credit — J. Noffsinger — R. I. Box 37, Greenville, Ky.



#### \$60 a Week—Now a \$10 Raise

Repaired sets others fell down on—promoted to foreman — Fred E. Klemann, Box 8, Lisle, Ill.

### Big R. T. I. Book FREE Now—Use the Coupon!

All you have to do is fill in the coupon and we will mail you, post paid, our wonderful book "Tune In On Big Pay." There is no other book like it. You will be startled, like thousands of others, with its thrilling pages—its amazing photographs—overwhelming evidence of the incomparable money-making opportunities for you in Radio—RIGHT NOW! Send for it immediately.

RADIO & TELEVISION INSTITUTE Dept. 76-A 4806 St. Anthony Court, Chicago

RADIO & TELEVISION INSTITUTE Dept. 76-A 4806 St. Anthony Court, Chicago Send me Free and prepaid your BIG BOOK "Tune In On Big Pay" and full details of your three-in-one Home Training (without obligating me in any way).

Name ..... Address ..... City ..... State .....



# 5,000

## Radio Service Men Needed Now!

The replacing of the old battery operated receivers with all-electric Radios has created a tremendous country-wide demand for expert Radio Service Men. Thousands of trained men are needed quick!



### 30 Days of R.T.A. Home Training

*... enables you to cash in on this latest opportunity in Radio*

**\$40 to \$100**  
*a week*  
**Full Time**  
**\$3.00** *an hour*  
**Spare Time**

Ever on the alert for new ways of helping our members make more money out of Radio, the Radio Training Association of America now offers ambitious men an intensified training course in Radio Service Work. By taking this training you can qualify for Radio Service Work in 30 days, earn \$3.00 an hour and up, spare time; prepare yourself for full-time work paying \$40 to \$100 a week.

#### More Positions Open Than There Are Trained Men to Fill Them

If you were qualified for Radio Service Work today, we could place you. We can't begin to fill the requests that pour in from great Radio organizations and dealers. Members wanting full-time positions are being placed as soon as they qualify. 5,000 more men are needed *quick!* If you want to get into Radio, earn \$3.00 an

**We furnish you with all the equipment you need to become a Radio Service Man!**

hour spare time or \$40 to \$100 a week full time, this R. T. A. training offers you the opportunity of a lifetime.

#### Radio Service Work a Quick Route to the Big-Pay Radio Positions

Radio Service Work gives you the basic experience you need to qualify for the big \$8,000, \$10,000 to \$25,000 a year Radio positions. Once you get this experience, the whole range of rich opportunities in Radio lies open before you. Training in the Association, starting as a Radio Service Man, is one of the quickest, most profitable ways of qualifying for rapid advancement.

If you want to get out of small-pay, monotonous work and cash in on Radio quick, investigate this R. T. A. training and the rich money-making opportunities it opens up. No special education or electrical experience necessary. The will to succeed is all you need.

## Mail Coupon for No-Cost Training Offer

Cash in on Radio's latest opportunity! Enroll in the Association. For a limited time we will give to the ambitious man a No-Cost Membership which need not . . . should not. . . cost you a cent. But you must act quickly. Filling out coupon can enable you to cash in on Radio within 30 days, lift you out of the small-pay, no-opportunity rut, into a field where phenomenal earnings await the ambitious. You owe it to yourself to investigate. Fill out coupon NOW for details of No-Cost Membership.

**The Radio Training Association of America**  
4513 Ravenswood Ave. Dept. RCA-6, Chicago, Ill.

THE RADIO TRAINING ASSOCIATION OF AMERICA  
4513 Ravenswood Ave., Dept. RCA-6 Chicago, Ill.

Gentlemen: Please send me details of your No-Cost training offer by which I can qualify for Radio Service Work within 30 days. This does not obligate me in any way.

Name.....

Address.....

City..... State.....



H. GERNSBACK, President  
 S. GERNSBACK, Treasurer  
 J. M. HERZBERG, Vice-President  
 I. S. MANHEIMER, Secretary

R. D. WASHBURNE,  
 Technical Editor



HUGO GERNSBACK, Editor-in-Chief

JOHN F. RIDER,  
 Editor Service Dept.

C. P. MASON,  
 Associate Editor

VOLUME I  
 NUMBER 12

## Contents of This Issue

JUNE  
 1930

|   | PAGE                 |   | PAGE |
|---|----------------------|---|------|
| <b>EDITORIAL</b>  |                      | <b>NEW DEVELOPMENTS IN RADIO</b>                                      |      |
| Money in Summer Radio.....By Hugo Gernsback                                     | 617                  | How Tests of Audio Quality are Made<br>By Laurence M. Cockaday        | 632  |
| <b>SERVICE MEN'S DEPARTMENT</b>   |                      | The New Trend of the Radio Industry..By J. E. Smith                   | 635  |
| Study .....   | By John F. Rider 618 | Solving Television's Problems.....By Clyde J. Fitch                   | 636  |
| Helping the Service Man Make Money<br>By F. C. Rockhill                         | 619                  | New Radio Devices for Shop and Home.....                              | 637  |
| Leaves from Service Men's Notebooks<br>By RADIO-CRAFT Readers                   | 620                  | Simplified Automotive Radio Installation<br>By Samuel Egert           | 638  |
| Testing Apparatus for the Service Man<br>By Sylvan Harris                       | 621                  | <b>ON THE SHORT WAVES</b>   |      |
| A Quick Audio Testing Method...By Elden L. Cherry                               | 623                  | A Triple-Tuned R.F. Short-Wave Receiver<br>By S. H. Clayton           | 640  |
| Operating Notes for Service Men..By Bertram M. Freed                            | 624                  | How to Tune for Foreign Short-Wave Stations<br>By Arthur J. Green     | 642  |
| The Service Man's Open Forum.....   | 625                  | Short-Wave Operation from a "B" Power Unit<br>By L. H. Houck          | 643  |
| <b>RADIO SERVICE DATA SHEETS:</b>   |                      | Correspondence from Short-Wave Fans.....                              | 644  |
| Amrad "Model 81" ("Bel Canto" Series).....                                      | 626                  | <b>MODERN SOUND PROJECTION</b>  |      |
| Radiolas "24," "26," "Super VIII," and "Semi-Portable<br>Superheterodyne" ..... | 627                  | (V) Notes on Practical Maintenance Work<br>By Lawrence F. Heaphy, Jr. | 645  |
| Educating a Service Organization.....   | 628                  | The Cooperative Laboratory.....By David Grimes                        | 646  |
| Servicing with a Set Analyzer.....By John M. Forshay                            | 629                  | RADIO-CRAFT'S Information Bureau.....                                 | 648  |
| Men Who Have Made Radio (No. IX)—Frank Conrad                                   | 631                  | Reviews of Recent Radio Literature.....                               | 662  |
| Service Problems in Radiola Models.....By J. R. Duncan                          | 635                  | Statement of Ownership, etc. ....                                     | 665  |
|   |                      | RADIO-CRAFT'S Opportunity Column.....                                 | 667  |

## In Forthcoming Issues

### MONEY-MAKING IDEAS FOR THE SERVICE MAN.

Several articles have been prepared, dealing with methods which will be of use this summer to the enterprising radio worker. Among them are the modernizing of favorite old models of Atwater Kent, Radiolas, and other battery-operated receivers. Automotive radio in its latest developments will be described each month; the new Delco will appear in the July issue.

### NEW DEVELOPMENTS IN THE RADIO ART. Television

is coming closer and closer to the commercial stage. The latest additions to the art, both in this country and abroad, will be covered from month to month in RADIO-CRAFT. In Germany two noted inventors, Karolus and Mihaly, have made advances in television apparatus which will be fully described in an illustrated article by Dr. Fritz Noack.

And many other articles, all of current interest and value to the practical reader.

RADIO-CRAFT is published monthly, on the fifth of the month preceding that of date; its subscription price is \$2.50 per year. (In Canada and foreign countries, \$3.00 a year to cover additional postage.) Entered at the postoffice at Mt. Morris, Ill., as second-class matter under the act of March 3, 1879. Title registered U. S. Patent Office. Trademarks and copyrights by permission of Gernsback Publications, Inc., 98 Park Place, New York City.

Text and illustrations of this magazine are copyright and must not be reproduced without permission of the copyright owners. We are also agents for WONDER STORIES, AMAZING DETECTIVE TALES and WONDER STORIES QUARTERLY. Subscriptions to these magazines may be taken in combination with RADIO-CRAFT at reduced Club rates. Write for information.

Copyright 1930. GERNSBACK PUBLICATIONS, INC.

Published by  
**TECHNI-CRAFT PUBLISHING CORPORATION**

Publication Office: 404 No. Wesley Ave., Mount Morris, Illinois

Editorial and Advertising Offices  
 96-98 Park Place, New York City

Western Advertising Office  
 737 North Michigan Avenue, Chicago, Ill.

L. F. McCLURE, Western Advertising Representative

London Agent: Hachette & Co.,  
 16-17 King William St., Charing Cross, W.C. 2

Paris Agent: Hachette & Co.,  
 111 Rue Reaumur.

Australian Agent: McGill's Agency,  
 179 Elizabeth St., Melbourne



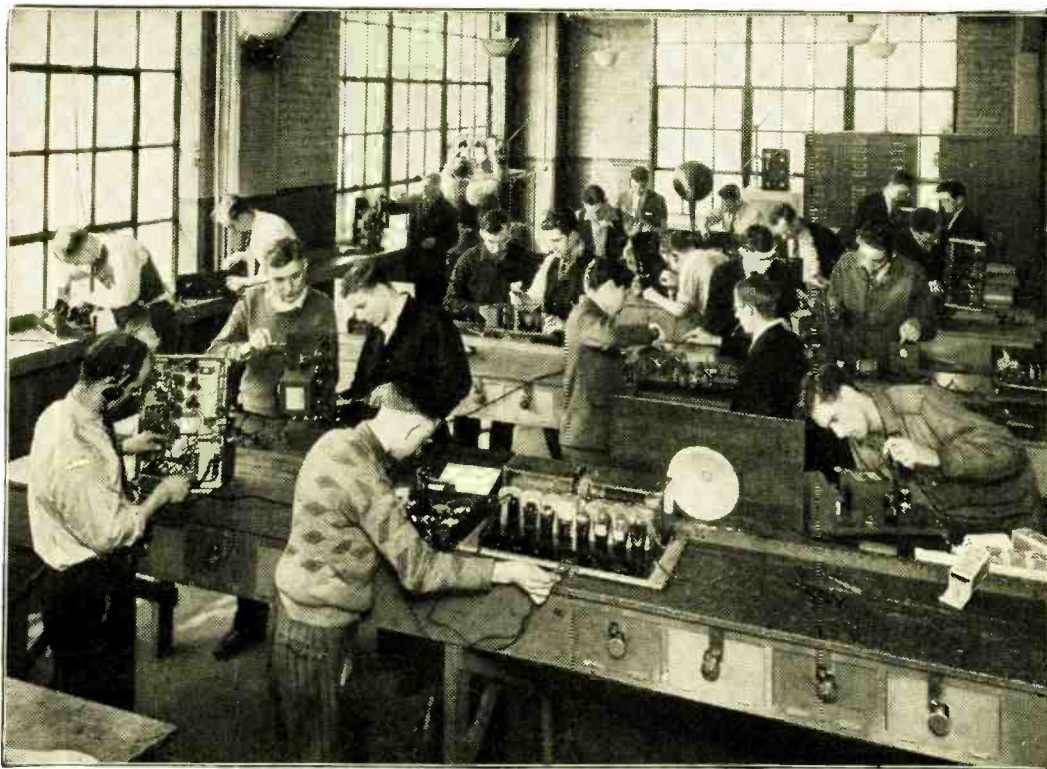

# YOU Radio Men!

**S**TATISTICS in the radio industry show that at the present time the ordinary radio man, either as a repair man or Service Man, makes an average of \$35.00 a week. Let us show you how you can quickly qualify for jobs leading to salaries of \$60.00, \$70.00, or \$100.00 a week and up—NOT by books or correspondence, but by an entirely new way.

## We Teach You How—No Books—No Lessons—No Classes!

Coyne is not a correspondence school. We actually show you, by expert instructors, every phase of radio; which it is impossible to learn from books or from correspondence courses.

The majority of Radio Service Men and radioticians today do not earn what they should, because they have never been properly grounded in the fundamentals of radio—that is to say, in electricity.

Remember, you will never qualify as an expert radio man unless you know the fundamentals of electricity. All of this is taught by ACTUAL WORK on real equipment in our school.

## From \$20.00 a Week to \$100.00 a Week

"Before going to Coyne, I had worked in a garage for five years at \$20.00 a week. I had no advanced education and didn't know a volt from an ampere. Yet I graduated in three months with a grade of 98%. Since I left Coyne, I have jumped from \$20.00 to \$100.00 a week, and am still going strong. I owe all my success to the practical training I got in the Coyne Shops."—Harry A. Ward, Iowa.

**COYNE ELECTRICAL SCHOOL, H. C. Lewis, Pres.  
500 S. Paulina St. Founded 1899 Dept. AO-85, Chicago, Ill.**

Most self-taught radio Service Men fail utterly because their electrical education has been neglected; and, incidentally, they lose a good income because statistics show that radio alone cannot support the independent radio man all year around.

In the Spring and Summer time, particularly, radio is notoriously dull; and the radio man who is an electrical expert will make more money in the end.

## Radio Training

The photograph above shows how men are actually trained in our big radio shop, where students are shown by experts how to take apart and put together the various modern radio sets. We will show you how to get at the root of servicing troubles; and within 90 days you can be a radio expert.

Most radio men today flounder around because they do not know the peculiarities of many sets, and have to puzzle these out, tediously, for themselves; whereas our instructors, with years of experience behind them, can show you how to locate any set troubles.

## No Previous Training Necessary!

Remember, I do not teach you out of books. You are actually doing the work yourself, and get all the experience you need right here at Coyne.

I do not care whether you cannot tell a vacuum tube from a C-battery; whether you are sixteen years old or forty-five. It is my job to prepare YOU for a big-pay radio and electrical job in 90 days' time.

## The Future of Radio

At the present time, there is a dire need for REAL and experienced Service Men, who

also know the ins-and-outs of electricity. Even though you may work on a good salary job for an employer at first, sooner or later you will wish to establish yourself in your community and start in business for yourself. The combination of radio and electricity cannot be beat; it is an all-year-round business.

Even if you do not want to go in business, there are more jobs today than good men to fill them. Coyne training settles the job question for life. Only recently one concern called on me for 150 graduates, and calls for more men are coming in daily. Coyne maintains an expert Employment Department, which will help you and back you up as long as you live, WITHOUT ONE CENT OF COST TO YOU.

## Special Offer!

In connection with the radio training, you are also given electrical training in all its branches—auto ignition and aviation electricity—WITHOUT ONE CENT EXTRA COST!

## Get My Free Book

Mail the coupon today, and let me send you the big Coyne book of 150 photographs—facts—jobs—salaries. It costs nothing, and does not obligate you in any way. Just mail the coupon.

## MAIL THIS COUPON—NOW!

Mr. H. C. LEWIS, President  
COYNE ELECTRICAL SCHOOL, Dept. AO-85  
500 S. Paulina St., Chicago, Ill.

Dear Mr. Lewis:

Without obligation send me your big free catalog and all details of Railroad Fare to Chicago, Free Employment Service, Radio, Aviation Electricity, and Automobile Courses, and how I can "earn while learning."

Name .....  
Address .....  
City ..... State .....



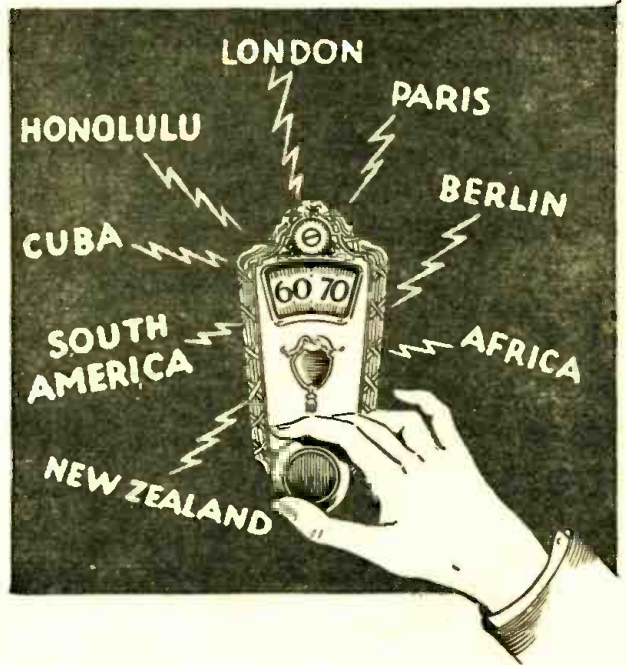

# Parade of International Radio DIRECT from Foreign Stations

See Nearest Dealer or  
Write Direct for Details

**Without Dependence On  
Local Re-Broadcasting!**

Kit K-115: The A.C. Super  
Wasp. Use your own ABC  
pack or Pilot K-111 at  
\$16.50, specially designed  
for the Super-Wasp. Power  
Pack and Tubes Extra

**\$34<sup>50</sup>**

## PILOT SUPER-WASP

Short Wave and Broadcast Receiver  
RANGE 14 TO 500 METERS

*In Kit Form for A. C. or Battery Operation*

Kit K-110: The battery-  
operated Super-Wasp.  
Batteries and Tubes extra

**\$29<sup>50</sup>**

**Widen Your Circle of Entertainment!**

Your broadcast receiver is useless below 200 meters, but the Super-Wasp, swooping down to 14 meters, and up to 500, unlocks a new world of trans-oceanic radio you never heard before! And you get it directly from the foreign station and not from a local rebroadcast. Enthusiasts report European, African, South American and Australian stations. Music amazingly new! Welcome variety for listeners "fed up" with domestic radio programs! To assure consistently satisfactory operation, Pilot engineers developed the Pilotron P-227, which naturally makes it a splendid tube for broadcast receivers.



## PILOT RADIO & TUBE CORP.

323 BERRY STREET  
BROOKLYN  
N. Y.



Chicago Office: 234 South  
Wells Street  
San Francisco Office: 1278 Mission  
Street

## JOINING THE RADIO INTERNATIONAL GUILD

**A** Costs only 50c and includes lapel pin, certificate and "Radio Design" Construction Quarterly Magazine, the Guild's Official Organ. Enclose 50c coin or stamps to Radio International Guild, 103 Broadway, Brooklyn, N. Y.



Name.....  
Address.....  
City..... State.....





# My NEW Book is ready for You

**IF you're in Radio now spare time or full time - it will show you how my improved training can help you make still more money**



**J. E. SMITH, Pres.**  
NATIONAL RADIO INSTITUTE

**If you're not in Radio / this book will show you how you can get in quickly !**

Radio's amazing growth is opening hundreds of fine jobs every year, in broadcasting stations, with Radio dealers, jobbers, manufacturers. Shipping companies offer you many chances to travel all over the world without expense and make good money besides. There are almost unlimited opportunities for a profitable spare time or full time Radio business of your own. My graduates have jumped from \$25, \$35 and \$40 a week to \$50 a week, \$60 a week, \$75 a week and \$100 a week. My book proves this.

**I will train you at home in your spare time**

Hold your job—I will train you inexpensively in your spare time. I'll give you practical Radio experience with my 50-50 method—one-half from Lesson Texts and one-half from practical home experiments with Eight Outfits of Radio parts that I furnish. I will refund your money if you are not satisfied with my Lessons and Instruction Service when you finish.

**I will show you how to make \$10 to \$30 a week in spare time repairing sets while learning**

The day you enroll I'll show you how to do ten jobs common in most every neighborhood. I'll show you how to repair and service all makes of sets and many other jobs. I'll give you the plans and ideas that are making \$200 to \$1,000 for my students while they are taking my course.

**Find out what Radio offers you. Get my new book**

My book gives you the facts. Tells you where the good Radio jobs are, what they pay, how you can fit yourself right at home in your spare time for a good job in Radio. Tells you about the many extra services and material that the National Radio Institute gives its students and graduates. It shows you what others who have taken the N.R.I. course have done; what they think of it. Get the facts. There's no obligation.

**J. E. SMITH, President**  
**NATIONAL RADIO INSTITUTE**  
Dept. OFY Washington, D. C.

**Before you do anything else Get the dope on my new...**

*Eight Outfits of Radio Parts for a home experimental laboratory covering screen grid, A. C., and many other features in the latest sets.*

*Service Sheets and Service Manuals giving up-to-date and authentic information on servicing different models and makes of sets.*

*Work Sheets and Job Sheets which show you how to make extra money in your spare time while taking my course.*

*Improved Lesson Texts covering thoroughly all branches of Radio.*

*Instruction material on Talking Movies, both the Vitaphone and Photophone systems.*

*Training in Television and home experiments in Television reception.*

*These are only a few improvements. My book, "Rich Rewards in Radio," tells you all about 18 features of my course as I give it today.*

Have you read my new book giving an outline of National Radio Institute's training in Radio? If you haven't, send for a copy today. No matter what kind of a job you may have in the Radio industry now, unless you are at or near the top, I believe my training can help you forge ahead—make still more money. However, I'll let you decide that for yourself—just let me show you what I have to offer. Many others in Radio—amateurs, spare time and full time service men, Radio dealers, fans—have found the way to more profits and more money through my course.

**See what I offer those who are now or who want to be service men**

While my course trains you for all branches of Radio—I am giving extensive, thorough, and complete information on servicing different models and makes of A. C. and Screen Grid Sets. Atwater Kent models, Crosley, Zenith, Majestic, Stewart-Warner, Radiola, Eveready and many other makes of sets are covered. This information is of special help—of real money-making value—to those who are now service men or who want to be expert service men. This part of my training, however, is only one of 18 outstanding features that I am offering men and young men who want to get good jobs in Radio—or who are in Radio and want to advance themselves. Even though you may have received information on my course before, unless you have gotten my new book as pictured above, write to me again—see how N.R.I. has grown with Radio's growth and how N.R.I. Radio training has grown and improved too. Organized in 1914, it took the lead then in Radio training and it has kept that lead ever since. This course is not new or untried. Hundreds of men owe their success and larger incomes to N.R.I.

**CLIP AND MAIL THIS Coupon DO IT TODAY**

J. E. SMITH, President, National Radio Institute, Dept. OFY, Washington, D. C.

Dear Mr. Smith—Send me your book, "Rich Rewards in Radio." I want to see what N.R.I. offers.

Name .....

Address .....

City..... State.....

Are you doing Radio work now?.....



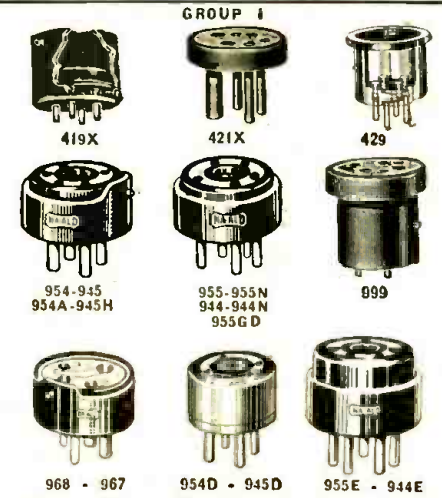

GROUP 1—ADAPTERS PUTTING ANY TUBE INTO ANY SOCKET

|   |      |
|---|------|
| 419X—UX199 Tube in UV201A Socket.....           | .35  |
| 421X—UX Tube in WD11 Socket.....                | .75  |
| 429—UV199 Tube in UX or UV201A Socket.....      | .75  |
| 944—UX to UX Raises Tube 3/4".....              | 1.00 |
| 944E—UX to UX Raises Tube 7/8".....             | 1.00 |
| 945—UX Tube in UX Socket.....                   | 1.00 |
| 945D—UX Tube in UX Socket (small diameter)..... | 1.00 |
| 954—UY Tube to UX Socket.....                   | 1.00 |
| 954D—UY Tube to UX Socket (small diameter)..... | 1.00 |
| 955—UY to UX Raises Tube 3/4".....              | 1.00 |
| 955E—UY to UX Raises Tube 7/8".....             | 1.00 |
| 967—UV201A Tube in UX Socket.....               | 1.00 |
| 968—WD11 Tube in UX or UV201A Socket.....       | 1.25 |
| 999—UX Tube in UV199 Socket.....                | 1.00 |

GROUP 2

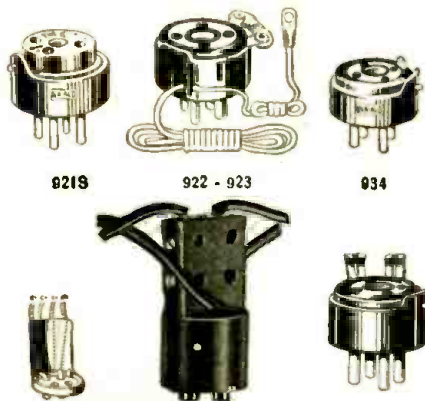

GROUP 2—CONNECTORALS AND ADAPTERS FOR IMPROVING YOUR SET

Write for List of Connectorals for Adding Power Tubes; Adapters for Conversion, D.C. to A.C.

921S—Adapter for cushioning microphonic tubes in either UX or UV201A Sockets..... 1.25

922—Adapter for adapting any UX socket for UV224 Shielded Grid Tube..... 1.50

923—Ditto for UX 225 Tube..... 1.50

934—Adapter for oscillation control in R.F. stages (takes Grid Suppressors of values 200, 300, 500, 700, 1,000 ohms)..... 1.25

R200 to R1000—Grid Suppressors for 934 Adapter..... .25

944FF—1-hole, 4-prong break, both filaments for voltage reducing testers for 245 Power Tube..... 1.25

GROUP 3

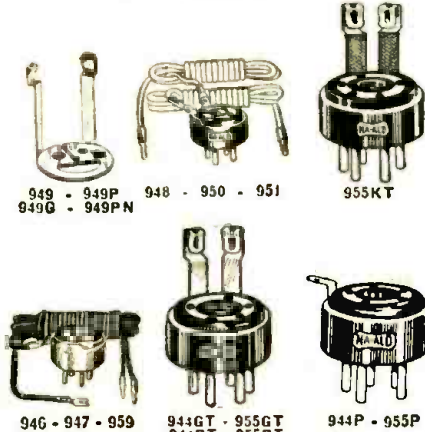

PRODUCTS

Whatever Your Requirements of Adapters, Plugs, Sockets and Connectorals, we have them or can make them, write us

GROUP 3—ELECTRIC PICKUP ADAPTERS

|  |      |
|--|------|
| 944P—UX Adapter with single plate lead.....  | 1.25 |
| 955P—UY Ditto.....   | 1.25 |
| 944GT—UX Adapter—Grid Break with tip terminal.....   | 1.25 |
| 955GT—UY Ditto.....  | 1.25 |
| 944PT—UX Plate Break Ditto.....  | 1.25 |
| 955PT—UY Ditto.....  | 1.25 |
| 946—UX Adapter Plate hole dead—Plate Prong Lead to Pickup—other Pickup Lead to B Supply..... | 1.50 |
| 949—Connects Pickup to Grid Circuit of UX or UY Tubes.....                                   | .60  |
| 949P—Connects Pickup to Plate Circuit of UX Tubes.....                                       | .60  |
| 949G—Like 949, omit lead to fil.....   | .60  |
| 949PN—Like 949P, omit lead to fil.....   | .60  |
| 948—Connects Pickup to Plate Circuit of UY Tubes.....  | 1.50 |
| 948A—Ditto—Includes Radio Phono Switch and By-Pass Condensers.....                           | 4.00 |
| 950—Connects Pickup to Grid Circuit of UX Tubes.....   | 1.50 |
| 951—Connects Pickup to Plate Circuit of UX Tubes.....  | 1.50 |
| 955KY—Connects Pickup to Cathode Circuit of Screen Grid Sets.....                            | 1.25 |
| 955KC—Ditto with Clips for Soldering.....  | 1.25 |

GROUP 4



GROUP 4—ADAPTERS FOR CONNECTING POWER AMPLIFIERS TO ANY SET

|  |      |
|--|------|
| 933—For attaching A.C. Sets to Power Amplifiers, plate break; clips on P hole, P prong and K.....  | 1.25 |
| 947—Recommended by Victor for connecting Radiola 16 to Electrola Power Amplifiers.....   | 1.50 |
| 952A—Recommended by Sanson for connecting PAM Amplifiers to A.C. Sets; with R.F. By-pass Condenser.....  | 2.25 |
| 953A—Ditto for D.C. Sets.....  | 2.00 |
| 959—To connect input transformer of power amplifier to P of 5-prong tube and direct to B supply. Breaks plate, lead to P hole and extra lead to connect to plus fil..... | 1.50 |

GROUP 5

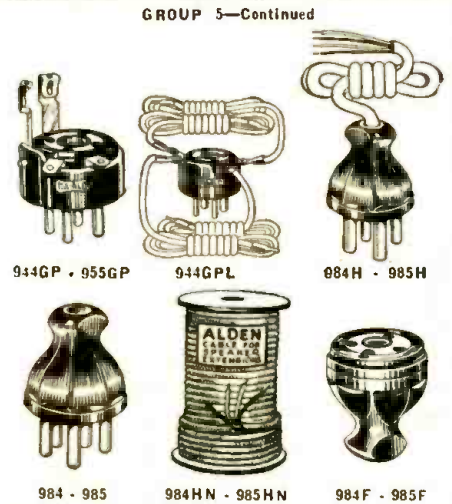
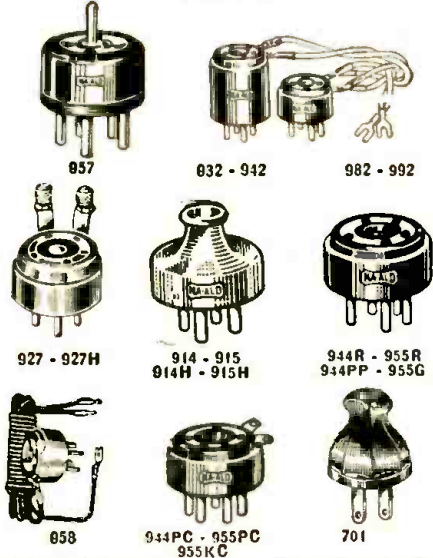

GROUP 5—ADAPTERS AND PLUGS FOR THE SERVICE MAN (See Other Groups)

Combine! An Adapter Kit for Service Men—Write if interested

|  |       |
|--|-------|
| 701—Alden Suregrip Attachment Plug.....  | .15   |
| 914—4-Prong Armored Plug (No Harness).....   | .25   |
| 914H—Ditto with 40" Harness.....   | 1.25  |
| 915—5-Prong Armored Plug (No Harness).....   | .25   |
| 915H—5-Prong Ditto with 40" Harness.....   | 1.25  |
| 927—5-hole 4-prong—lead clips to III, Fil prongs are shorted.....  | 1.25  |
| 927H—5-hole 4-prong—lead clips to III, Fil prongs not shorted—for replacing McCullough tubes with A.C. Tubes.....  | 1.25  |
| 932—Testing 222 Tubes in Jewell Testers.....   | 4.00  |
| 942—Testing UY Tubes in Jewell Testers.....  | 4.00  |
| 944F—UX Fil. Break for Measuring Current.....  | 1.25  |
| 944FF—UX Adapter—Connects Ammeter to Fil. Prongs.....  | 1.25  |
| 944GP—Test Adapter 4-prong, making detector of any R.F. stage, breaks grid circuit for grid leak and condenser, also breaks plate with phone tip terminals for headphones..... | 1.25  |
| 944GPL—Adapter for measuring voltage impressed on both plates of No. 280 Tubes.....  | 1.50  |
| 944GT—UX Adapter—Breaks G with Tip Jacks. Other connections through.....   | 1.25  |
| 944N—UX Neutralizing Adapter—One F Dead.....   | 1.00  |
| 944PC—UX Plate Break—Solder Clips.....   | 1.25  |
| 944PP—UX Adapter to Test 2d Plate of 280 Tube.....   | 1.00  |
| 944R—UX Heavy Duty Tube Checker Adapter Socket.....  | 1.50  |
| 944PT—Adapter for listening in on UX Detector Tubes with Headphones.....   | 1.25  |
| 955PT—Ditto for UY Detector Tubes.....   | 1.25  |
| 955G—UY Adapter for Testing 224 in Weston Testers.....   | 1.25  |
| 955H—UY Adapter Heater Break for Measuring Terminals.....  | 1.00  |
| 955GD—Adapter for Testing 224 Screen Grid Tubes—G post dead.....   | 1.00  |
| 955GP—UY Test Adapter, making detector of any R.F. stage, breaks grid circuit for grid leak and condenser, also breaks plate with phone tip terminals for headphones.....      | 1.25  |
| 955GT—UY Adapter breaks G with Tip Jacks—Other Connections through.....  | 1.25  |
| 955HH—UY Adapter—Connects Ammeter to H prongs.....   | 1.25  |
| 955N—UY Neutralizing Adapter—One H Dead.....   | 1.00  |
| 955PC—UY Plate Break—Solder Clips.....   | 1.25  |
| 955R—UY Heavy Duty Tube Checker Adapter Socket.....  | 1.50  |
| 945H—Like 945 but K connected to adjacent II.....  | 1.00  |
| 953A—Like 954 but K not connected to adjacent H.....   | 1.00  |
| 957—4-hole 5-prong with Top Center Stud.....   | 1.25  |
| 958—5-hole 4-prong with Bottom Center Stud.....  | 1.25  |
| 982—Victor Adapter—Recommended in Service Manual.....  | 5.00  |
| 984—4-prong all Bakelite Plug (No Harness).....  | .50   |
| 984F—UX Connector Plug—Socket End for 4 Conductor Dynamic Speaker Extension.....   | 1.00  |
| 785F—UY 5 Conductor Ditto.....   | 1.00  |
| 984HN—4 Conductor Speaker Cord—100 ft. Coll.....   | 8.00  |
| 985HN—5 Conductor Speaker Cord—100 ft. Coll.....   | 10.00 |
| 984H—4-prong all Bakelite Plug with Harness (10").....   | 1.50  |
| 985—5-prong all Bakelite Plug (No Harness).....  | .60   |
| 985H—5-prong all Bakelite Plug with Harness (10").....   | 1.50  |
| 992—Twin Adapter for Testing 224 Tube in Jewell Testers with proper wiring.....  | 4.00  |

GROUP 6—SOCKETS

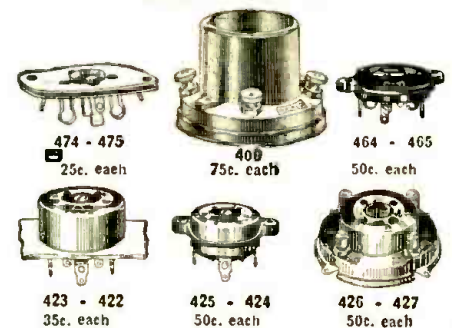

Send Stamps for new Descriptive Catalog and list of a large variety of parts at special prices

Dept. R-6

ALDEN MANUFACTURING CO.

Brockton, Mass.



# Chemistry Offers You



## A Fortune

### If You Want a Job with a Future, Get into Chemistry



T. O'Connor Sloane,  
A.B., A.M., Ph.D.,  
LL.D.

Chemistry is one of the most ancient and honorable callings known to man. During the Middle Ages its adepts were the advisors of kings. Then it was called a black art and its followers were believed to have supernatural powers.

The chemist of today with his modernized knowledge has secrets a thousandfold more potent at his command. He is the brains behind hundreds of rich industries, which could not exist without his skill. Yet the field of Applied Chemistry has spread so widely that it is difficult to get enough good men to fill the available posts. A chemical expert is always sure of a good income, a respected and confidential position and a guaranteed future. He may also make himself a fortune, as hundreds of chemists have done before him. Did you ever hear of C. M. Hall? He was an American chemist who at the age of twenty-one discovered how to extract aluminum from clay. It was known that this could be done. It remained for someone to experiment and do it. There are innumerable other chemical problems today waiting to be solved. Mr. Hall died a few years ago leaving an estate of many millions of dollars.

#### WE CAN TEACH YOU AT HOME

In order to become a chemical expert you must have the proper training under experienced teachers. Our faculty knows just how to mold you into a skilful laboratory worker. The head of our staff is Dr. T. O'Connor Sloane, scientist, engineer and author of wide repute. He has had more than fifty years of teaching experience. Our course fits you for an immediate position in a chemical laboratory, and you do not have to give up what you are doing now to learn it. During evenings and week-ends you can work at home on the fascinating experiments and the delightfully simple but comprehensive lessons. A personal tutor is always ready to help you over difficulties and to answer all your questions. Most important of all—the teaching you receive is practical. You can actually use this knowledge to make money, as thousands have done before you.

#### SPECIAL ADDED EQUIPMENT

At no extra charge every student is given a complete cabinet of chemicals and apparatus for his own use. The illustration gives some idea of what it contains. There are over fifty distinct chemical reagents in the set. But in addition there is something which we have never offered before. The chemical expert needs sharp eyes. For much of his work no human eyes are keen enough. Every modern scientist resorts to the microscope, which is one of the most valuable instruments in home or laboratory.



We give to every student, without additional charge, this chemical equipment, including fifty-two pieces of laboratory apparatus and supplies, and fifty-two different chemicals and reagents. These comprise the apparatus and chemicals used for the experimental work of the course. The fitted heavy wooden box serves not only as a case for the outfit but also as a useful laboratory accessory for performing countless experiments.

#### Diploma Awarded When You Graduate

Upon graduation every student is awarded our Diploma in Chemistry, certifying that he has successfully completed his studies. Your name on this certificate will be a source of pride to you all your life, as well as an aid in obtaining a position.

#### We Are Now Sending to Each New Student ABSOLUTELY WITHOUT CHARGE THIS VALUABLE MICROSCOPE

It is a beautiful instrument of fine German make and extremely sensitive. Any person not a student of our course may procure one through us at \$25.00, which is somewhat less than the usual price, but to those who enroll the microscope will be given ABSOLUTELY WITHOUT CHARGE. With it you will receive a special lesson on its construction and use. The microscope is not loaned to you. It becomes your permanent possession along with all the other equipment and the lessons.

#### TUITION PRICE REDUCED

No advance in tuition price is occasioned by this newest addition to the apparatus we supply. In fact we have even reduced the fee, so that this splendid course and equipment are within the means of every individual who is interested in following Chemistry, whether as a career or merely as a hobby. Fee can be paid on EASY MONTHLY TERMS. The one price covers everything. There are no extras to buy.

**MAIL THE COUPON TODAY FOR FREE BOOK**

**CHEMICAL INSTITUTE OF NEW YORK, INC.**

16-18 East 30th Street

New York, N. Y.



**CHEMICAL INSTITUTE OF NEW YORK, INC.**  
Home Extension Division 6  
16-18 E. East 30th Street, New York, N. Y.

Please send me at once, without any obligation on my part, your free book "Opportunities for Chemists," and full particulars about the Experimental Equipment given to every student. Also please tell me about your plan of payment and the reduction in the tuition price.

NAME .....

ADDRESS .....

CITY ..... STATE .....

EG-6-30



# Announcement!



BOARD OF DIRECTORS

L. M. COCKADAY

DAVID GRIMES

JOHN F. RIDER

HUGO GERNSBACK

SIDNEY GERNSBACK

I. S. MANHEIMER



## NATIONAL RADIO SERVICE MEN'S ASSOCIATION

**E**VER since the appearance of the commercial radio broadcast receiver as a household necessity, the Radio Service Man has been an essential factor in the radio trade; and, as the complexity of electrical and mechanical design in receivers increases, an ever-higher standard of qualifications in the Service Man becomes necessary.

The necessity, also, of a strong association of the technically-qualified radio Service Men of the country is forcing itself upon all who are familiar with radio trade problems; and their repeated urgings that such an association must be formed has led us to undertake the work of its organization.

This is the fundamental purpose of the NATIONAL RADIO SERVICE MEN'S ASSOCIATION, which is not a money-making institution, or organized for private profit; to unite, as a group with strong common interests, all well-qualified Radio Service Men; to make it readily possible for them to obtain the technical information required by them in keeping up with the demands of their profession; and, above all, to give them a recognized standing in that profession, and acknowledged as such by radio manufacturers, distributors and dealers.

To give Service Men such a standing, it is obviously necessary that they must prove themselves entitled to it; any Service Man who can pass the examination necessary to demonstrate his qualifications will be elected as a member and a card will be issued to him under the seal of this Association, which will attest his ability and prove his identity.

The terms of the examination are being drawn up in co-operation with a group of the best-known

radio manufacturers, as well as the foremost radio educational institutions.

The following firms are co-operating with us:

- GRIGSBY-GRUNOW CO., CHICAGO (Majestic)
- STROMBERG-CARLSON TELEPHONE MFG. CO., ROCHESTER, N. Y.
- CROSLEY RADIO CORP., CINCINNATI, OHIO
- COLIN B. KENNEDY CORP., SOUTH BEND, IND.

The schools who have consented to act as an examination board are:

- International Correspondence Schools, Scranton, Penna.; Mr. D. E. Carpenter, Dean.
- RCA Institutes, Inc., New York, N. Y.; Mr. R. L. Duncan, President.
- Radio & Television Institute, Inc., Chicago, Ill.; Mr. F. G. Wellman, Managing Director.
- Radio Training Association of America, Chicago, Ill.; Mr. A. G. Mohaupt, President.
- School of Engineering of Milwaukee, Milwaukee, Wisc.; Mr. W. Werwath, President.
- Rider-Goll Radio School, New York, N. Y.; Mr. John F. Rider, Director.

We shall not attempt to grade the members into different classes. A candidate will be adjudged as either passing or not passing. If the school examining the papers passes the prospective member as satisfactory, we shall issue to him an identification card with his photograph.

If the candidate does not pass this examination the first time, he may apply for another examination three or six months later.

There is absolutely no cost attached to any service rendered by the Association to its members, no dues, no contributions.

If you wish to become a member, just fill out the coupon below and mail it to us. We will send you all the papers necessary to become a member.

N. R. S. M. A.,  
c/o RADIO CRAFT,  
98 Park Place,  
New York, N. Y.

I wish to become a member of your Association. Please mail me the examination papers and application blanks.

Name .....

Address .....

Town..... State.....

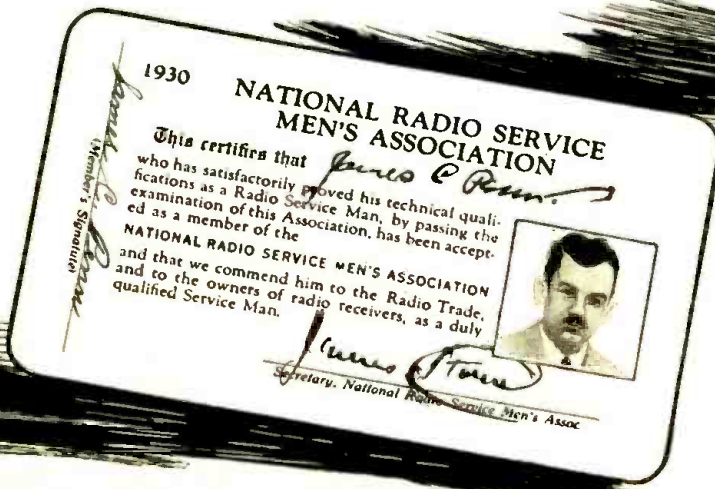



## Money in Summer Radio

By Hugo Gernsback

**I**T is accepted without question, by most of those who are interested in radio as a business, that sales must drop off in the summer and that it is impossible to make much money in radio during that season.

It may be true that sales of commercially manufactured receivers always fall off in summer, and that business in this line is poor from May until September; but this is not the case with sales of radio parts, and in other lines of which I will speak later. During the summer vacations, after the schools have closed, there is usually an upswing in the parts trade, amounting to a high figure, and due principally to young men who do a great deal of experimenting and building.

But the man, old or young, who wishes to make some extra money during the summer time, will find open many avenues to such income through radio. Even when business conditions are poor in other lines as well, there are many individuals who know how to go about it and make quite a little money in this way.

First, it is logical to service sets in the summer; because they have accumulated dust, etc., through the winter, and the tubes have been used until replacement is desirable. The time to put the receiver in shape is, normally, the late spring or early summer. We know a number of men who have made quite a little money by sending out to set owners circulars calling the need of servicing to their minds, and offering to do general overhauling for a minimum charge.

Many sets are unprovided with lightning arresters and the average owner, if the matter is called to his attention, will be willing to spend a few dollars for better protection; especially if his home is located in the suburbs or country. This installation work alone will afford a nice source of income.

Another is found in the business of renting sets. During the summer, particularly, at resorts, the outdoor restaurants, parks, places of amusement, require radio. Sometimes the set can be sold outright; very often individuals wish to rent them. Since locations in many cases are not wired for standard line-current requirements, the battery set is most desirable. Second-hand and even unused sets can be bought today at exceedingly low figures and, in many cases, a month's rental will bring in nearly as much as the original cost.

An excellent business can be done with boys' and girls' camps; of which there are literally thousands, all over the country. Most of these have no radio set, and would gladly install one if it could be acquired at a reasonable figure. Here again a used set will be ideal for the purpose, and make possible a sale at a handsome profit to the man who installs it.

The same statement is true of summer colonies near beaches and lakes, and the so-called tent cities, bungalows, congregations, etc. With a little intelligent salesmanship, a respectable proportion of these can be sold on radio. We remember going through one of these summer camps, near the Jersey coast, where there were some three hundred bungalows. The year before, there had not been two radio sets there; but last year there was one in at least every other house.

Then, too, there is opportunity for an excellent business in portable sets; which, strange to say, seems to be almost entirely neglected in this country, although in Europe the portable is a close rival to the larger sets in popularity. There seems to be no good reason for this neglect of the possibilities in the sale of portable sets; most people who go camping during the summer will wish one, if the right approach is made to them. Automobile tourists are especially good prospects; and, with a little intelligent inquiry, it should be easy to find out who are planning trips and sell them automotive radio installations.

It is interesting to note also the increasing demand for community public-address and music amplifiers, which has been reported by Mr. J. E. Smith, president of the National Radio Institute. His survey shows that these amplifiers, adapted to all manner of public entertainment, bring about an excellent community spirit and incidentally, they give an excellent professional standing to the local Service Men who install and maintain them. There are many opportunities for the arousing of local public interest in the acquisition of apparatus which can be used at outdoor gatherings in the summer, as well as for semi-permanent installation in a local auditorium; and they are excellent business builders.

In short, there are a great many more opportunities, besides the few suggested here, which may be seized by the wide-awake radio man who is looking for a source of additional, and welcome, profits from his technical and sales ability during the summer months ahead of us.



# Service Men's Department

*This department is about the Service Man, for the Service Man, and largely by the Service Man. Its contributors are practical men, and we invite every Service Man in the country to tell about his own experiences of all kinds*

Edited by JOHN F. RIDER

## STUDY

By John F. Rider

**T**HE subject of radio covers a great deal of ground and involves many subjects, some simple and some complex, but at best of sufficient number to make matters interesting. Of the many men allied with the industry, the Service Man is the most closely allied to the engineer—at least he should be. Whether or not he is at that stage is a matter of personal effort. It may sound strange to devote all of this space to such an unpopular subject as study, but its importance is becoming more evident each day.

The modern radio receiver is a scientific device. Basically it is identical with the receiver of yesterday; yet a detailed comparison shows one to be a mountain and the other a molehill. One or more engineers of the highest calibre have spent a good deal of time in the development of a radio receiver—the modern receiver. Money and laboratory facilities have been at their disposal. As a result, they produce a receiver that involves what may generally be termed complex radio actions. This receiver is placed into production and, like all things electrical, eventually finds its way into the hands of the Service Man. Can he correct the defect? It is a problem of moment.

The answer must of necessity be two-sided, "Yes" and "No": the former because many such receivers are actually repaired; and the latter because many more such receivers are not repaired. The difference between the two is in just what knowledge may be possessed by the individual who takes the receiver in hand. Perhaps you, as the reader of this page, imagine that we are recommending immediate recourse to text books. Not exactly. We are, however, suggesting faithful perusal of all modern radio literature published in periodicals and, furthermore, suggest concentrated study of modern radio receiver design.

We have made the statement that the modern receiver differs from the old. Nothing shows this more clearly than an examination of the wiring diagrams of two such pieces of radio apparatus; as a matter of fact, we ask comparison of a 1929 and a 1930 radio receiver. The receiver produced today is no longer what we believe it should be, if we base our beliefs upon past installations and past performances. The modern radio engineer is no longer a copyist. We cannot say that he is an originator, since the basis of radio receiver design is not new; but the modern engineer is incorporating innumerable items and systems which were absolutely unknown to old receiver design.

The presence of these additions complicates matters—for the Service Man who is



**M**R. JOHN F. RIDER, who passes upon all the material submitted for publication here, in the Service Men's Department, is a radio engineer of the first rank who has devoted much energy to the popularization of technical knowledge. None excel him in the art of making difficulties clear; he is a practical instructor, and the author of books known by all Service Men as useful guides. Letters, stories, requests and suggestions for this department may be addressed to him in care of RADIO-CRAFT.

not aware of their existence. The complete receiver is a structure of coordinated units; each functions in conjunction with the other. The failure of any one part reacts upon the rest. All must be correct, in order that the receiver may function in the normal manner. These improvements are, unfortunately, seldom related to the D.C. voltages encountered in a radio receiver, that is unless one part fails. When this happens, and the presence of the new system is not recognized, trouble shooting becomes an absolute waste of time.

We appreciate that many practical workers who are short on theory are servicing radio receivers today. But we cannot admit that such an individual is as well fortified as the man who is also familiar with theory and can comprehend the modern installation, can analyse the modern wiring diagram and interpret its structure. The wiring diagram plays an important role in radio service work. As a matter of fact, too much dependence is placed upon that diagram—entirely too much—at a sacrifice of more vital data, the comprehension of what is indicated upon that diagram, and its significance relative to manifestations in the case of trouble.

Take as a modern example, the use of hum-neutralizing systems in the output audio stages, whereby a certain portion of the

A.C. hum in the filter is deliberately fed into the plate circuit of the output stage, and a fraction of that is fed into the grid circuit. The location of this system, which incidentally consists of a capacity and a resistance, is such that, in the event of a defect in the condenser or a short-circuit within the unit, the grid bias applied to that tube will be appreciably increased; since the resistance mentioned will then function as a bleeder and supply more current through the grid-bias resistance. The normal reasons for excessive grid voltage and low plate current do not apply in this case. Measurement of the circuits which govern plate current and grid voltage will not indicate the fault. Further, a casual investigation of the wiring diagram will not bring the hum-neutralizing system to light; it will appear a part of the voltage divider. Correction in a reasonable amount of time, so that the work is actually profitable, is possible only when the presence of such neutralizing circuit is known and appreciated.

The above is only one of many such instances. An open circuit in the above-described system will produce hum in the output; yet every other item, including the D.C. voltages, will be found normal. Set analyser tests will be of no avail. Normal continuity tests will likewise prove of no avail unless the Service Man knows of the hum-neutralizing system in use, its location and component parts.

The modern radio engineer is including low-pass filters in detector and output plate circuits; he is using parallel resonance in the "B" unit filter. Recognition of such circuits is imperative. One is accustomed to the use of high capacities in "B" filter systems. Yet we find values between .01- and 0.3-mf. used across the speaker field windings which are employed as chokes in the "B" filters. The presence of that parallel capacity of small value is essential to the operation of that radio receiver. Its action in conjunction with the choke is to introduce maximum attenuation, at the fundamental hum frequency, in the "B" filter. Its omission, or an open in the condenser, will in no way affect the output D.C. voltages, but it will increase the hum to an appreciable extent.

The modern grid-bias circuit differs from the old. The bias voltage developed across a grid-bias resistance is no longer due to the plate current of that tube or the other tubes associated with that resistance. Addition of the associated plate currents and calculations of the voltage developed across the known grid-bias resistance will produce a discrepancy. The resistance will appear low, yet the correct voltage will be produced. Why? Simply because bleeder resistances

(Continued on page 650)



# Helping the Service Man Make Money

*The exercise of ingenuity will find new applications for his radio knowledge which will enlarge his income; besides amplifiers and built-in radio, what can our readers offer?*

By F. C. ROCKHILL

**T**HE most important thing to the Service Man, who is in radio for a living, and not for a hobby, is to obtain a good return for his skill and labor. Even the amateur, if he devotes spare hours to work for others, should consider that time is money.

What RADIO-CRAFT and its readers want is practical articles telling how money is being made out of radio service; for those which bring out really new ideas, that offer a profit to the Service Man, an extra rate will be paid. They should be accompanied by diagrams and good photos, if possible; as it is necessary to illustrate them for publication.

**M**UCH has been said and published, in the past two years, about the opportunity for the Service Man to make more money in the talking-movie field; and then the usual article would go on to describe an installation that would run into thousands of dollars, and which would be installed by the company selling it. As a result, all service would be rendered on this installation by that company, whose Service Man would call at stated times to keep it running; and our local Service Man would be left out in the cold, with another good chance gone.

Scattered throughout the country there are, literally, thousands of small theatres that can not afford to install talking pictures or even one of the higher-priced non-synchronized outfits; since the volume of business done will not return them enough profit to make this a wise investment. This is where the local Service Man steps into the picture; since, with the advent of the '45 power tube, an amplifier can be built, using this tube in push-pull, that will cover a theater seating 500 with good quality and volume to spare, and at a cost that is not prohibitory.

Most of these small theaters are struggling along with a piano player, and a few have also a drummer. All of them are not located in small towns; for many of the smaller neighborhood theaters are in the same boat. The problem of selling to the owner is lessened, because his patrons are demanding better music. He is probably trying to figure out how to install one of these systems without tying up too much money; so your visit will be a welcome one.

I am describing an installation which was made by me for a theater seating 350, but is large enough for one seating five hundred people. The amplifier was built with a 7 x 17 inch sub-panel, and a 7 x 18 inch front panel which carries the input and output binding posts, switch and volume control (Fig. 1). Three stages of amplification are used; the first two employ the

Clough system of parallel-plate coupling, using '27s, while a pair of '45s in push-pull comprise the output stage (Fig. 2). The power pack is one of the new Pilot "K112s," which furnishes ample power for this amplifier.

The sub-panel was wired first; the transformers were lined up along the front with the input stages at the right and the push-pull stage at the left. The tube sockets for the '45s are mounted behind the push-pull transformers, the '27s next, at the right, and the '80 in the rear right corner (as seen from the front).

The reproducer posts are located on the front panel at the lower left (Nos. 1 to 6); the output transformer used permits

180." The post at the left (No. 7) leads directly to the plate of the first '27; and the one at the right (No. 9) to the plate post of the input coupling unit. By changing the input leads from one post to another, the first tube may be cut out.

(Note: when a tube is cut out, better results may be obtained by taking the first tube from its socket. The volume is reduced a lot without this tube; but is generally sufficient unless the theatre is crowded. This tube was incorporated in the amplifier, however, because the owner wishes to put in a table, some day, for synchronized talking pictures.)

### Keeping Noise Down

Motorboating is quite apt to occur in an amplifier having so high a gain as this one, with good low-frequency response; so special precautions were taken to offset this. The '27s are biased by 1500-ohm resistors R1, R3, connected from cathode to ground; and these are by-passed by 2-mf. condensers, C2, C3. The 45s are biased by a 750-ohm resistor R6, connected to ground from the center tap of a 30-ohm potentiometer R5 across the filaments, and by-passed by another 2-mf. condenser C4. The 180-volt tap feeding the plates of the '27s was also by-passed with a condenser of the same size, C1. These measures have eliminated all tendency to motorboat.

The volume control is the 100,000-ohm potentiometer R4, placed in the grid circuit of the second '27, and affords excellent control with no external noises when in use. While this control changes the tone of the amplifier somewhat, there is advantage in this fact; as some of the defects in the acoustics of the theatre may be overcome by setting the volume control in the right place.

In contradiction to the general belief that the hum level in amplifiers of this kind may

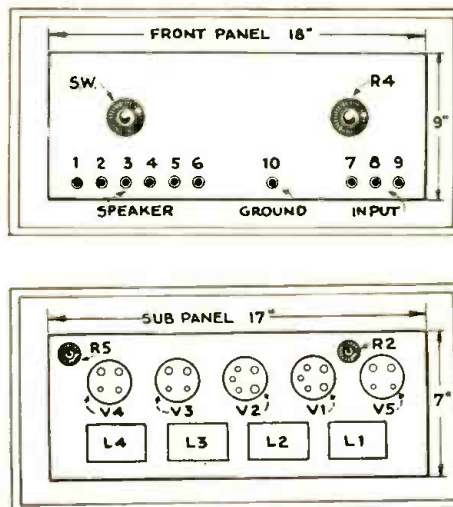

Fig. 1

The panel arrangement and layout of Mr. Rockhill's phonograph amplifier for a small theater.

matching the impedance of the speakers. At the bottom right are the three input posts; that in the center (No. 8) is led to "B+

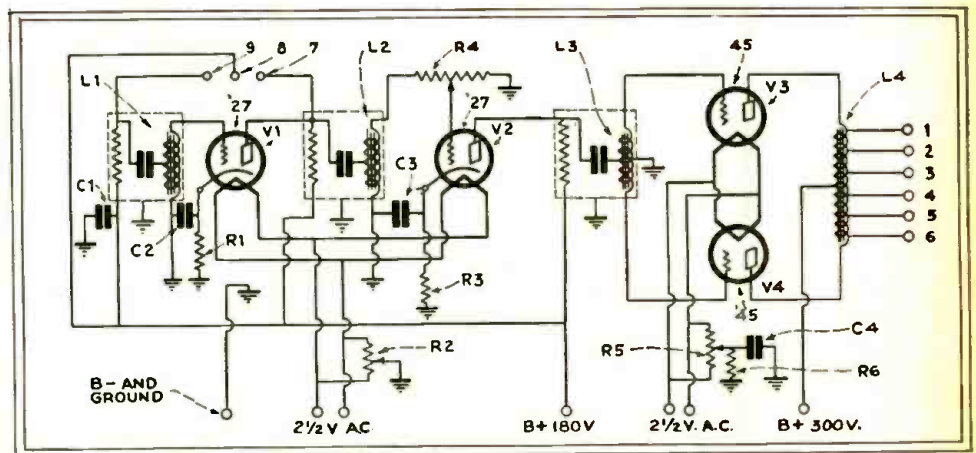

Fig. 2

The circuit of the three-stage amplifier; the power supply is from a standard kit.



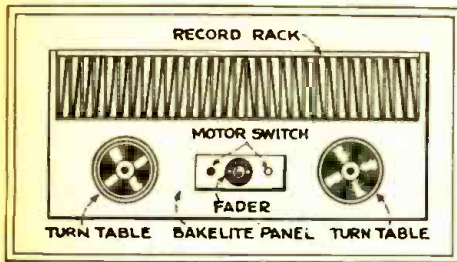

Fig. 3

The arrangement of the pick-ups and fader control, on a common library table top.

be high, it was found impossible to tolerate more than in a well-designed set for home use. The potentiometers R2 and R5 were placed across the filament supply wires as shown; the filament pairs were twisted tightly together. The transformer cases were grounded to "B—" with the exception of I4, which was found to work better, and with less hum, without grounding.

The pickups were mounted on a common, small library table which was obtained at second-hand, and proved just the thing for the purpose. Two Gordon induction motors were mounted, as shown in Fig. 3, with a switch for each motor, and a fader to change from one to the other.

Acoustical Problems

The speakers used were two "Radiola 106" dynamics, and were placed one on each side of the screen; here it was necessary to do a little experimenting to find the positions giving the best results.

Here are two suggestions; a common fault is reverberation, which causes an overlapping of musical tones and speech. A good test for this is to have some person stand near the horns and speak with conversational loudness, while another goes to different parts of the theatre and listens for a "hang-over" at each pause.

Echo is generally present when the music sounds blurred, or stuttering; but it must be remembered that an echo is a distinct reflection of whatever was spoken or played, and is best noticed at the end of a phrase. A good test is to have someone stand by a horn and clap his hands while another listens from the floor of the house. The man clapping should gradually increase the rate until a steady "putt-putt" is heard, and if an echo is present, it will suddenly come midway between claps, so that the strokes

appear to double. An echo commonly affects only certain seats, or rows; and patrons can help to determine which seats are affected.

One should compare the quality of reproduction with different-sized crowds in the theatre; for each listener has about twenty-five square feet of sound-absorbing surface. When defects are found, they can be corrected easily by placing absorbent material in suitable places until the correct effect is obtained; there are several good materials on the market, and which to use is a matter of personal choice.

The parts used in the amplifier illustrated were: L1, L2, L3, Silver-Marshall "Nos. 255, 256, 257"; I4, "S-M 228" (or 248); power pack, Pilot "No. K112"; R1, R3, R6, Electrad "Type B" resistors, two 1,500-ohm, one 750-ohm; R2, R5, Pilot "No. 930-1P" 30-ohm potentiometers; R4, Pilot "No. 941 Volungrad," 0-100,000-ohm; C1, C2, C3, C4, Pilot "No. 9302" condensers, 2-mf.; Sw, one Pilot "No. 44" switch; sockets, binding posts, hardware, etc.

Built-In Radio

Before closing this article, I wish to return to the financial aspect of radio service, with which we started, and ask Service Men how many of you, during the past few years, have noticed the trend toward built-in furniture, without giving a thought to built-in radio?

I admit that I was one of those who did so, until a building contractor in my town came in to ask whether he could buy a radio receiver without a cabinet, since he wanted it built into the wall of his home. He asked

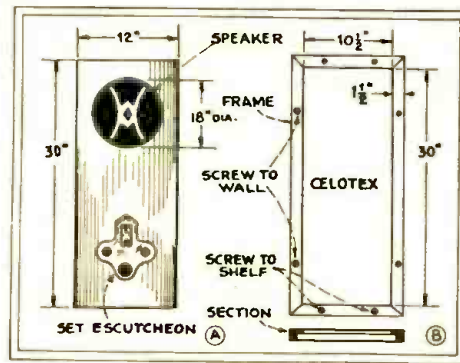

Fig. 5

The front panel and one wall of the sound-proof box for the built-in receiver. Top, back and the other sides were similarly constructed.

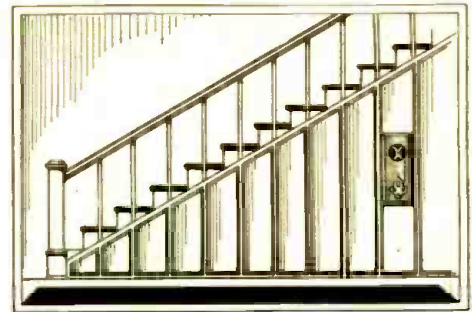

Fig. 4

From a piece of decorative furniture, radio is now evolving into the final stage of a part of the building—like the light fixtures and plumbing. The skillful Service Man should find many opportunities in this idea.

me to come up and give him an estimate of the cost. I found that he wanted the installation under a flight of stairs—an ideal place, since there was plenty of room to work and a good location for the set. (Fig. 4.)

A Silver-Marshall "722 Band-Selector Seven" with an "S-M 851" speaker was chosen; of course, the Service Man has the choice of any of the good custom-built sets on the market, or of designing his own.

A panel, 12 x 30 inches, was taken out of the side of the wall, and replaced by one of wood veneer, cut as shown in Fig. 5A. The escutcheon furnished with the kit was placed over the holes in the panel, to make a finished-looking job.

The receiver was placed on a shelf, which fitted snugly to the front panel, and the speaker on a smaller shelf just above it. They were then enclosed with celotex, fastened to a frame which was assembled with screws. (Fig. 5B.)

The panel, of course, had been previously stained and varnished to match the fittings of the room; the hole for the speaker was cut out with a small keyhole saw, as indicated. Aerial and ground leads were brought in through the side wall of the house, and an outlet box was placed near the set for the power supply; so that not a single wire showed in the room where the set was placed.

A good charge can be made for work of this type; for the average radio dealer is quite unable to handle it. The Service Man has here an almost limitless field to work in; it will pay him to advertise locally that he is able to provide "Built-In Radio."

Leaves from Service Men's Note Books

AERIAL RESISTOR RESTORES SELECTIVITY

By Frank J. Moch

THE owner, a friend of mine, asked me to look at a Zenith "Model 52 Old English" set that had been serviced by two other Service Men. Each reported that WBBM, a strong station here in Chicago, would butt in on almost every other station on the dial.

Each man made routine tests on the set, checked aerial and ground, found everything O.K., and turned in the job as a case of poor location.

I found things just as my predecessors did. I tried placing a fixed condenser in the aerial circuit and different lengths of aerial string in different directions, but still no

improvement. Finally I placed a 50,000-ohm resistor between the aerial wire and the aerial post. By this time I was getting disgusted. I turned on the set, really expecting no improvement; but, on the contrary, it worked perfectly. (This arrangement is used in several commercial receivers.—Editor.)

LOOSE CONNECTION PROBLEMS

By Henry Burwen

CONCRETE experiences in solution of individual service problems, I think, are among the most helpful forms of information Service Men can acquire. Here are two interesting experiences.

On a Crosley D.C. "Showbox" one of the '71A tubes burned out several times. No

apparent reason for it could be discovered; as the set in all cases tested normal and (Continued on page 654)

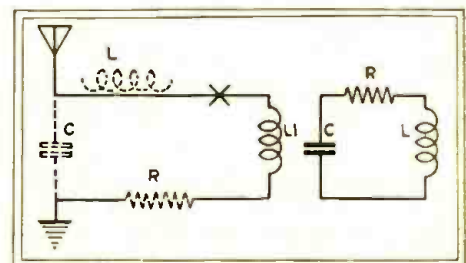

Any antenna is a resonant circuit, with distributed inductance, capacity and a small resistance. Increasing the resistance makes a circuit more difficult to "shock" into oscillation.



# How to Test Radio Receiver Performance

*The use of simple apparatus to obtain efficiency and compare sets*

By SYLVAN HARRIS

IT is becoming apparent, more and more, day by day, that a large part of the rapid growth of the radio industry has been due to the Service Man, and to the service departments of the manufacturers of radio equipment. In a similar manner, the enormous growth of the automobile industry has been due to its service men; for who would want to own and run an automobile that could not be immediately serviced when in want of repairs? The ability to obtain parts on a moment's notice, and to find men capable of making the necessary repairs, is an extremely important feature for the prospective car purchaser to consider. Likewise, it is just as important for the prospective radio set purchaser to consider what his standing would be in case something should go wrong with his set.

People are finding this out to-day. Take, for example, sets which are no longer made and the parts for which are obtainable only with difficulty, if at all. It is necessary for the Service Man to substitute parts of other manufacture and, for this reason, he must know the characteristics of the parts he wants to replace and of the parts he wants to use in the replacement. Furthermore, when the job has been done, it is necessary for him to find out if the set works properly, as it should work. Again, there are sets which are now obsolete (since they are operated by batteries and without a power stage) which the present owners want converted to A.C. operation and to include a power stage. All this requires a knowledge of the components to be used, as well as the manner of connecting them in the circuit.

And finally, sets get out of order; it is necessary for the Service Man to be able to diagnose the trouble properly and quickly. Until then, he cannot intelligently prescribe the cure. Just so, in medicine, the physician has his instruments and uses them: he takes the temperature with his thermometer; measures the blood pressure with his sphygmomanometer; makes chemical and microscopic examinations of the blood, sputum, etc.; takes X-ray pictures; and what not. The more serious the case, the more carefully must he study it.



**WHEN** is a set working at its highest efficiency? What is the comparative amplification of two receivers? What are their "characteristics" as regards quality? These things cannot be judged by the ear; but Mr. Harris gives rules for measuring them with simple apparatus in the Service Man's shop.

Of course, the radio Service Man's job is not a case of life and death, in the literal sense; but it is vital so far as it concerns his ability to make a living and, in that way, keep himself and his family in good health—so that the M.D. will not be called upon to perform his service work. And so, the radio Service Man must know how to diagnose radio troubles quickly and accurately, and then how to correct them. And to make such diagnoses properly, he must have the proper instruments; we shall describe some of the latter.

### Design of the Oscillator

Perhaps one of the most important instruments for the Service Man to have, at least

for his shop use, is a modulated oscillator. With this instrument he can test the sensitivity and selectivity of radio receivers as complete units, and, if he wants to spend the money for a small D.C. meter, he can test the alignment of variable condensers. Such a modulated oscillator is shown in Fig. 1.

This is an instrument which everybody can build, and which can generally be assembled from miscellaneous parts found around any shop. There are two '01A tubes used, one as a radio-frequency oscillator and the other as an audio-frequency oscillator. The R.F. oscillator (shown at the left of the diagram) includes an ordinary three-winding coil 1.1-2-3 and a variable condenser C (with a trimmer VC). The ordinary coils and condensers used in T.R.F. receivers are suitable for this purpose; if they do not happen to have three windings it is a simple matter to wind on about ten turns which can act as the coupler L3, to be connected to the antenna and ground binding posts. The R.F. circuit is seen to be a simple tickler-coil oscillator; the radio-frequency currents being confined to the plate circuit of the tube by the .001-mf. by-pass condenser C1 and the radio-frequency choke RFC1.

The audio-frequency oscillator is likewise a tickler-coil circuit; the only difference being that the coil used is a regular audio-frequency transformer, marked A.F.T. The primary side of the transformer is connected in the plate circuit of the A.F. oscillator tube, and also across C1 in the plate circuit of the R.F. oscillator; while another R.F. choke RFC2 is between the plate and the audio transformer. Thus, the A.F. voltages established in the plate winding of the transformer are used to modulate the R.F. oscillator; the .001-mf. condenser and the R.F. chokes keeping the radio-frequency currents out of the A.F. oscillator circuit.

This arrangement generates a carrier wave which is modulated by a single tone. The tone will change slightly as the wavelength is varied, but this will cause no inconvenience for ordinary testing. The pitch of the tone can be varied, by substituting different audio transformers, or by adding

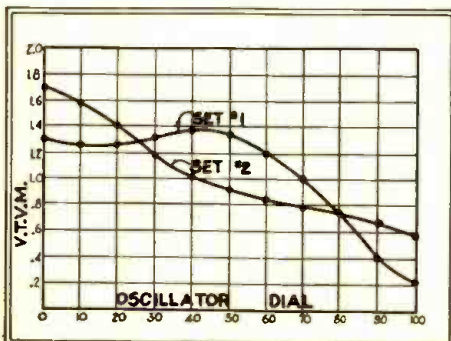

Fig. 4

The output of two sets, plotted thus, shows their comparative sensitivity at different wavelengths.

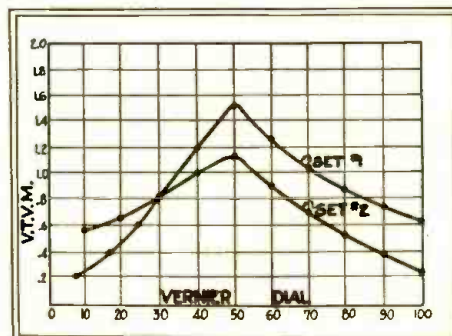

Fig. 6

This is the method of obtaining a selectivity comparison between two receivers, at any given wavelength. It is quickly made and accurate.

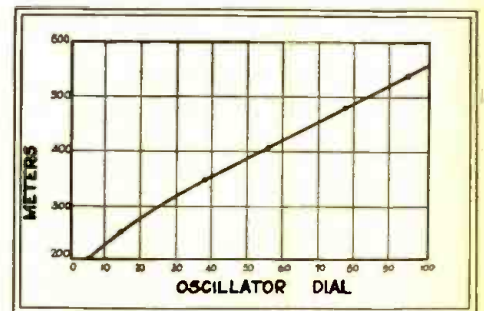

Fig. 7

An oscillator should be accurately calibrated, on a ruled sheet, in the manner explained here. Broadcast stations may be used as frequency standards.



a fixed condenser C2 as indicated by the dotted lines. If the particular audio transformer chosen has sufficient self-capacity, or if its secondary inductance is low enough, the condenser C2 will not be needed. The best tone to work with is around 1,000 cycles, or slightly less.

The grids are biased by about 4 volts. The particular value required can easily be determined by trial. Merely change the bias until the system oscillates strongly and steadily. Separate switches are provided for the two tubes; so that either a modulated or an unmodulated carrier can be obtained.

The whole outfit, "B" and "C" batteries included, can be built in the same metal shield. It is best to have the oscillator completely shielded, so that the amount of radiated power can be easily controlled. By setting up the apparatus in a corner of the shop, and connecting a couple of feet of wire to the antenna binding post, the signal may be radiated at a strength quite easily picked up by any radio receiver in the vicinity. If the signal is too strong, the antenna wire can be cut shorter.

**The Output Meter**

The next piece of equipment which we will have to consider is one which will enable us to measure the output power of the radio receiver. There are several ways in which this may be done; but perhaps the simplest and cheapest is to use a simple vacuum-tube voltmeter. It will be necessary to provide a small milliammeter, but the expenditure will be well worth while on account of the great utility of this instrument. The arrangement is shown in Fig. 2.

As the diagram shows, the instrument consists of an '01A tube operated from a small "C" battery as the plate supply, and having in the plate circuit a 0.2-milliamperere meter. The whole outfit (except the "A" battery) is contained in the same box. Although it is not absolutely necessary to shield the circuit, it is better to do so. The particular voltage to use depends on the tube, and should be so adjusted that the milliammeter needle just shows a small deflection (say 0.1-milliamperere) with the filament voltage at five volts.

Now that we have a modulated oscillator and a vacuum-tube voltmeter, let us see

what we can do with them. Suppose we have in the shop a receiver which we know is working properly, and we want to know how another receiver compares with it.

**Use of the Apparatus**

Start the oscillator going, over in a far corner of the room, and set up one of the receivers on a bench. Have the volume control full "on" and the proper voltages on the set. Connect the vacuum-tube voltmeter across the voice coil of the speaker, as in Fig. 3. To the antenna binding post of the receiver connect a .0002- or .00025-mf. condenser, to take the place of the capacity of the antenna ordinarily used with the set. The wiring (a), (b), (c) should be long enough only to furnish enough "pick-up" to give good deflections of the output meter. If the set uses a magnetic, instead of a dynamic, reproducer, the vacuum-tube voltmeter is merely connected across the speaker binding posts.

With everything started up, set the oscillator dial at zero and note the reading of

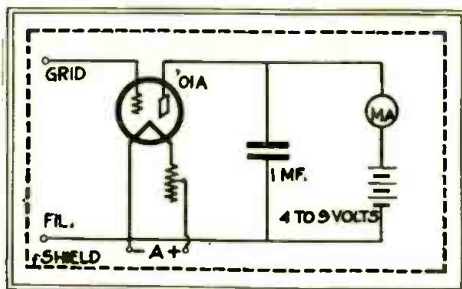

Fig. 2

The vacuum-tube voltmeter is very simple; it serves to measure the output of a receiver under test, and thus makes adjustment of condensers, neutralization, etc., a matter of exactness.

the output meter MA. If the signal is too weak, make the oscillator antenna longer, or increase the length of the wiring (a), (b), (c) on the receiver. Then take the reading of the output meter. Next set the oscillator dial at 10; and read the meter again. Repeat at 20, 30, and so on. But remember, while you are making these measurements, do not make the slightest change in the location of the oscillator, or of the set, or of the wiring of either antenna circuit. This precaution is of the greatest

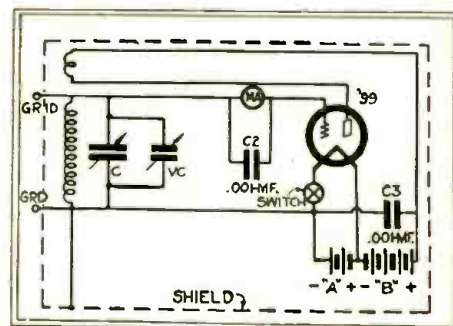

Fig. 8

A considerably smaller piece of apparatus than that of Fig. 1 is especially useful for alignment and balancing purposes. Its use is illustrated in Fig. 9.

importance; for otherwise you have no basis of comparison between any two measurements.

After finishing with one receiver, remove it and connect in the other. But remember, as emphasized above, the antenna must not be changed in the slightest while you are changing the sets. Take a similar set of measurements on the second set. While changing the setting of the oscillator dial, be careful that you do not move the oscillator.

When the two sets of measurements have been complete, they may be plotted in the form of curves as in Fig. 4. You will then have a very fair comparison between the sensitivities of the two receivers.

In order to be sure that nothing is changed while making the measurements, the two sets can be set up on the bench together, using switches to shift the antenna and the vacuum-tube voltmeter from one to the other (Fig. 5). The two curves may then be obtained at the same time.

**Determining Selectivity**

Now, suppose we want to make selectivity curves of the two sets. For this purpose we can add to our oscillator a "vernier" condenser (marked VC in Fig. 1) which has a capacity of about 25 micromicrofarads or .000025-mf. This vernier should have a separate dial of its own, reading from zero to 100.

Suppose we want to find the selectivity curve at a fairly short wavelength. Set the main dial of the oscillator at, say, 10, and the vernier exactly on 50. Then tune in the two sets very accurately. They are exactly in tune with the signal when the output meter shows its maximum reading; so you do not have to depend upon your ears, which are very unreliable anyhow.

Then take readings of the output meter with the vernier dial of the oscillator at zero, 10, 20, 30, etc., all the way around the scale. If the set is very selective you may get no readings when the vernier setting differs considerably from 50, which is the resonance setting.

Next, plot the readings so obtained on the two sets in the manner illustrated in Fig. 6. Although this does not afford a rigid comparison of the selectivities of the two receivers, it is nevertheless possible to learn a great deal about various receivers from these curves.

Next, it is desirable to calibrate the oscillator in terms of wavelength. This can be done very easily in the following manner:

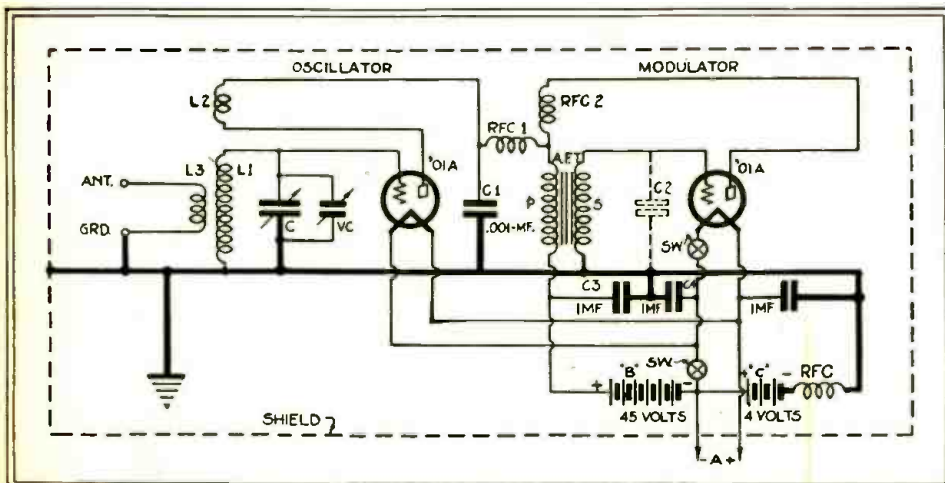

Fig. 1

A modulated radio-frequency oscillator is a familiar piece of apparatus; for the purposes of making such measurements as described here, it should be carefully calibrated. The coupler L3 need have very little wire attached to it to serve as a radiating aerial.



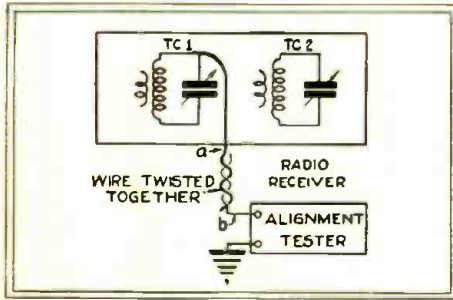

Fig. 9

The method of coupling the receiver's tuned stages, one at a time, to the small alignment tester of Fig. 8. The wires a-b form a small condenser.

Tune a radio receiver to any broadcast station, whose wavelength you have verified. Turn off the modulator tube in your oscillator, and vary the oscillator dial until you hear a loud whistle in the loud speaker. This is caused by your oscillator beating with the broadcaster. Adjust the oscillator dial very carefully, until zero beat is obtained. Suppose then you read the oscillator dial and find that it is at 10.5; and your newspaper tells you that the wavelength of the particular broadcaster is 247 meters. This is set down as a point on your calibration curve. Do this at various points, beating the oscillator against as many broadcasters as you can; then plot the curve, as shown in Fig. 7. But, remember, you must always have the oscillator vernier dial at the same setting; and it is convenient to make this 50. The vernier dial should be moved only when making selectivity curves.

**Testing for Alignment**

Now let us suppose that a customer sends to us a set which operated well until recently; in fact, until he moved from ..... Street to his new address. Now he can get only a few local stations, and these spread all over the dial. Upon studying the circuit and measuring tube voltages, checking the tubes, etc., you—the Service Man—can find nothing the matter with them. The poor selectivity and lack of sensitivity is so great that it is not necessary for you to run curves such as we have described above; for you can easily determine this by a simple trial "on the air." The first thing to suspect then, is that the alignment has gone bad. How can this be tested quickly and easily?

If you want to do so, you may use your

oscillator, as in Fig. 1, for making this test; but you will generally find it too powerful, and that it is more advantageous to build the alignment tester diagrammed in Fig. 8. This is nothing but a small, low-power oscillator using a '99 tube, and having the "A" and "B" batteries enclosed in the can. It is completely shielded, and can easily be built into a sheet-iron, brass or copper box, about 4 inches wide, 10 inches long, and 6 inches deep.

The capacity C is the tuning condenser of the oscillator, and VC is its vernier. A small 0-1.5-milliamper meter MA is connected in the grid lead of the tube as shown, and by-passed by a condenser C2. Now, in Fig. 9 we have indicated the receiver which is to be tested; in it there are a number of tuned circuits, two of which are shown, and

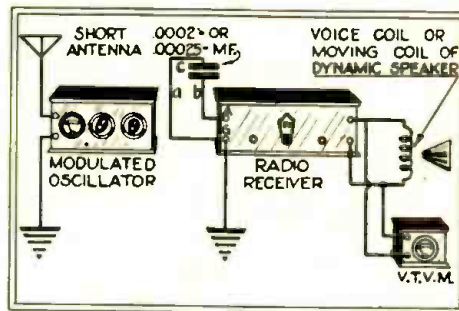

Fig. 3

The use of the oscillator and vacuum-tube voltmeter described; a, b and c constitute a small receiving antenna.

these are to be tested. Set the dial of the receiver at any wavelength where you want to make the test. Then take two pieces of insulated wire (a and b, in Fig. 9); b is

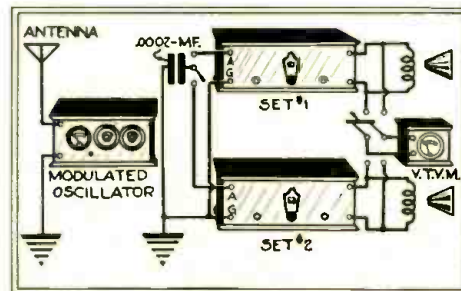

Fig. 5

To compare two receivers under absolutely equal conditions, switches may be used. The lengths of wire in the two pick-ups should be equal.

connected to the alignment tester, and is twisted several times around a. The other end of the wire a is touched against the grid side of the receiver's tuned circuit, that is, against the stator of the tuning condenser of the tester slowly, a point will be found where the milliammeter needle dips suddenly. Set this dial as closely as possible to the position at which the lowest dip is obtained; and then make the adjustment more accurate by varying the vernier VC. Take the reading of the vernier dial; then shift the wire a to another tuned circuit (TC2) in the receiver. This time, do not touch the main dial of the oscillator, but simply adjust the vernier VC. This test should be made on all the tuned circuits in the receiver.

The distance you have to change the setting of the vernier dial is a measure of how much the circuits are out of alignment. For perfect alignment, the vernier dial will always read the same. How much variation can be tolerated you will have to find out by experience with your own oscillator constants; after making measurements on a number of sets and trying these sets on the air, you can tell how much out of alignment a set may be and yet sufficiently selective for practical purposes.

This same arrangement can also be used for setting the trimmer condensers of a receiver. First, make your reading on the tuned circuit of the first stage; then connect the alignment tester to the second stage, and adjust the trimmer so that the vernier reads the same as for the first stage. Do likewise for the third stage and so on. The trimmers are usually adjusted at a short wavelength, say about 250 meters or less. After adjusting them in this manner, the alignment at other settings of the receiver dial should be checked.

In using the alignment tester there is one precaution to be observed. If, when you are adjusting the vernier of the oscillator, the needle of the meter is seen to dip slowly and, all of a sudden, bounce back, as it were, this is evidence that the coupling between the oscillator and the tuned circuit being tested is too tight. Untwist the two wires a turn or two, until it is found that the needle can be made to dip slowly and come back slowly. If this precaution is not observed, it will be impossible to take two readings of the same circuit which will be just alike.

**A Quick Audio Testing Method**

By ELDEN L. CHERRY

MOST set builders and old-time experimenters will remember that, when all sets were built "bread-board" style, we used to test the audio circuit by simply applying a finger tip to the grid leak. This gave us an immediate check on everything from the detector tube to the speaker. If, on touching the grid leak, a loud hum or buzz resulted, we knew that the audio channel and its component parts were all operative. A feeble response was due to a poor tube, low plate voltage or some trouble in the audio circuit or speaker. If no response at all was received, we knew that there was something radically wrong in this part of the set.

Since this test gives such immediate and effective check on so many parts of the set, it should be very useful to the Service Man. However, modern factory-built sets usually have the grid leak buried, somewhere under the metal chassis, in such a way that it is not accessible. Therefore, most Service Men, though they may be familiar with the method, do not attempt to use it on this account.

They have overlooked one good bet, however. Many late receivers have a phonograph pick-up, which usually consists of two tip jacks; one of these is connected di-

(Continued on page 654)

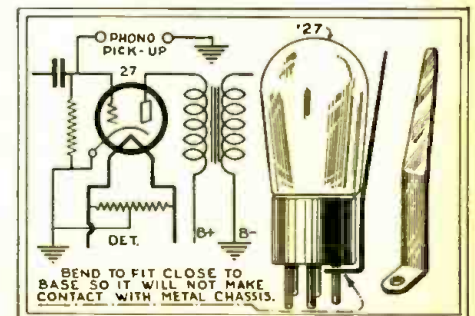

The grid of many a detector may be reached through the phonograph attachment; otherwise, the tool shown at the right comes in handy.



# Operating Notes for Service Men

*There are a good many useful ideas in the service manuals with which many Service Men are provided; other kinks are picked up only in the school of experience. Here are some of a scholar's reminiscences.*

By BERTRAM M. FREED

PERHAPS the problem of connecting a phono-pickup, to a commercial set using power detection, has confronted the Service Man. This can easily be done, if directions are followed closely, in

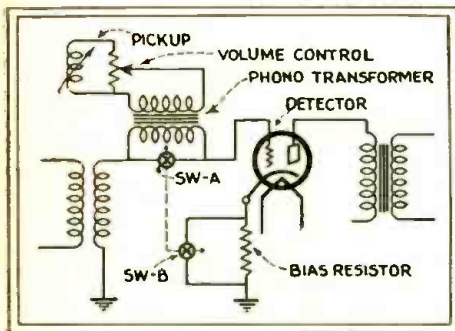

Fig. 1  
The standard system of connecting a "phono-radio" switch; it is most convenient to use a single knob to control both A and B.

this manner: referring to Fig. 1 we see switch A, in the grid circuit of the detector tube, and switch B, which shorts the bias of the detector tube. Switch A in closed position shorts out the phono-transformer, and in open position opens the detector grid circuit, thus connecting the phono-transformer into circuit. The two switches may be obtained in a single unit. In radio position, A is closed and B is open; in phono position, A is open and B is closed. However, in the "Radiola 64" and other sets which use the same chassis, an added switch must be inserted; for this model uses an automatic volume-control tube which is coupled to the detector tube through a small-capacity fixed condenser. Referring to Fig. 2, the third switch C must be inserted in the plate circuit of the automatic volume-control tube; then, we have this action: in radio position, A and C are closed and B is open; in the phonograph position, A and C are open and switch B is closed. Care must be taken to keep all leads as short as possible, to avoid introducing capacity and feedback in the circuit. Switches A, B, C may also be obtained in a single unit.

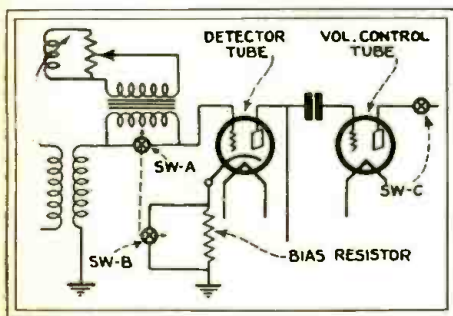

Fig. 2  
In late-model receivers employing an automatic volume control tube, it is necessary to disconnect this also when switching to the pick-up.

## Speaker Problems

Many cases have been found where the Sonora "A 44," when switched in the phono position does not have the original volume or "kick." The audio amplifier tests perfect in all respects and, when used with the radio-frequency side of the set has plenty of "kick." If the fault does not lie in the transfer switch (i.e., radio-phono switch) the trouble will be found in the Peerless speaker used, which is similar to the Cutting dynamic. It employs a single-turn copper-band voice coil, which is electrically and mechanically coupled to an output transformer, with a secondary winding of two heavy copper turns. The trouble lies where the voice coil is coupled to the secondary by two heavy nuts and bolts; corrosion takes place, or the bolts loosen up. To correct this trouble, the voice-coil contacts at the coupling should be cleaned and tinned; after which, the bolts should be fastened with good heavy pliers or a wrench. (Fig. 3.)

The "A 44" is designed for '50 type tubes which draw 55 milliamps each. If tubes which draw up to 60 milliamps (such as the CcCo) in this position are used, there will be a corresponding reduction in the R.F. plate voltage.

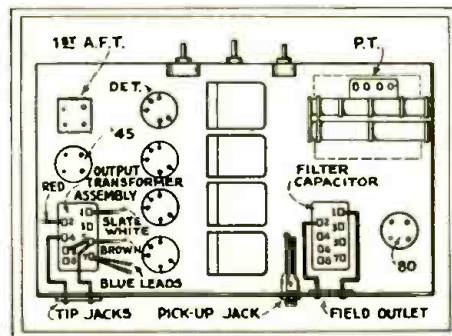

Fig. 4  
The layout of the Stromberg-Carlson "641" showing the connections to be changed when using it with an S-C dynamic.

Many Service Men may have been confronted with the task of wiring a Stromberg-Carlson "641" to take the D.C. dynamic speaker supplied by that company, which has a very high resistance field, and is connected across the D.C. output of the receiver. This necessitates increasing the A.C. plate voltage to the '80 rectifier. Connections to the plate terminals of the '80 are removed and taped up singly; the two brown leads in the same cable, now taped, should be soldered to the plates of the rectifier. The connections to the field outlet should be removed and taped up singly, and wires should be brought from the high voltage and chassis to this outlet. (see Fig. 4). The output choke and condenser device must be changed; it is necessary to remove the two blue leads from the speaker tip jacks. These blue leads are

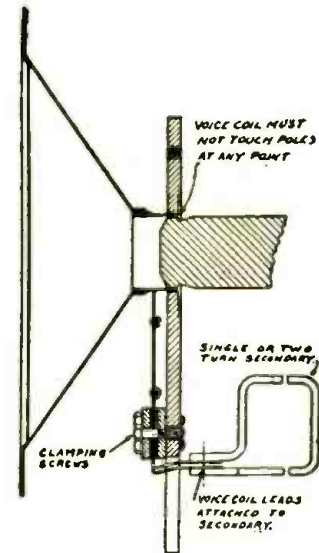

Fig. 3  
The mechanical arrangement of the Peerless and Cutting dynamics' voice coils

soldered to No. 7 terminal, after the wires connecting to No. 3 and No. 7 terminals of the output transformer assembly have been soldered to terminal No. 5. A lead from No. 4 terminal is run to the speaker tip jack to replace the blue leads, which originally were connected there. These are the only changes to be made. Referring to Fig. 4, we see the set after changes have been made; the wire from No. 5 to one of the tip jacks should not be disturbed. (The circuit diagram of this receiver is Data Sheet No. 1, which appeared in RADIO-CRAFT for October, 1929.)

Cases of poor reproduction, rattle, huskiness, and mushiness in "Radiolas 46, 62, 64," Victor "9-18" and Brunswick super-het models have been traced to the cone spider on the dynamic speaker, which had been broken.

## Causes of Hum

On sets using external power packs, such as Majestic and Freshman, it was common practice to insert a small fixed resistor in one filament leg of the '26's, '27's or '71A's. When this was done, the filament voltage

(Continued on page 653)

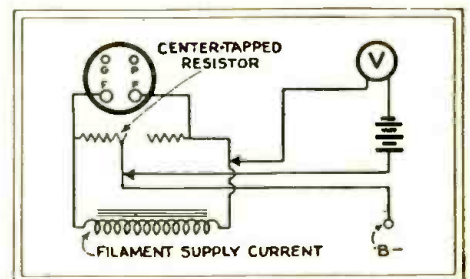

Fig. 5  
The tubes must be taken out, to make this test of continuity in the hum-balancing resistor.



# The Service Man's Open Forum

## ORGANIZATION NEEDED

*Editor, RADIO-CRAFT:*

I have read the complaints of a great many Service Men that they are not supplied with proper Service Data by set manufacturers. I can't agree with them at all, and I do not believe they have written to the manufacturers. Most likely they have dealt with some hard-headed distributor who honestly believes that these data will be used against his product. I have never been refused anything of this nature by the manufacturers. In fact, I have always found them only too willing to help us out. I admit that they are careful in giving out this material; but why shouldn't they be? When you stop to think about it, a service manual such as that supplied by Atwater Kent must cost fully two dollars to produce. This is the only one that costs us anything, and then only a dollar.

I have always found that, the larger the company, the more willing they are to help you out in any way they can. Even R. C. A., Victor and Sparton have supplied us with complete service data and binders for the same, without charge and without complaint.

Another thing I'd like to say is: I wonder if there is any way to organize the Service Men? I don't believe there is a single Service Man or service organization who would not be proud to belong to a suitable association, the benefits of which, I believe, are quite obvious and too numerous to mention.

In closing, let me say, or rather remind, all these Service Men to write to the manufacturer direct. He is the one who appreciates, by now, that it is through such service organizations as yours and mine that he is enabled to keep faith with the public.

M. S. WILSON,

*Rockcastle Radio Service,  
Covington, Kentucky.*

(Like many other Service Men who are keenly concerned with the future of the servicing profession, Mr. Wilson will be glad to learn that the necessary steps have been already taken to bring about an organization such as he suggests. The National Radio Service Men's Association is being formed; its purposes, as shown by the announcement which will be found on page 616 of this issue of RADIO-CRAFT, are to elevate the standards of the profession of radio servicing, and to bring about the recognition by radio manufacturers and the radio trade of the professional status of every well-qualified Service Man. All Service Men who are seriously engaged in the practice of radio servicing will find it to their interest to co-operate in its activities.—*Editor.*)

## A SATISFIED SERVICEMAN

*Editor, RADIO-CRAFT:*

I have been reading your magazine ever since it started, and expect to continue: for it is getting better with every issue. I notice every month, however, that some one makes a kick at not being able to get service data and cooperation from the manufacturers. It seems as though I have had better success than any one else; so I suppose I am to be considered fortunate.

## OPPORTUNITIES

The "Opportunities" column of this month's issue of RADIO-CRAFT will be found on page 667 of this issue. The Service Man who desires to take advantage of this feature may do so without cost, as explained there.

I wrote to 28 manufacturers asking for service data, and the replies on the whole were very gratifying. I was referred to the local distributor by three (Bosch, Brunswick, and Atwater Kent); two offered to sell theirs (Amrad and Splittdorf). The other twenty-three (Zenith, Day-Fan, Federal, Majestic, Philco, Steinite, Edison, Grebe, Eveready, Freed-Eisemann, Freshman, Stewart-Warner, Kolster, Balkite, Crosley, Lyric, Fada, Victor, Apex, Sparton, Arborphone, Acme, and Emerson) all forwarded me their service manuals and data sheets—quite a few of which were books giving data on all models; expensive outfits—and told me that they would be glad to cooperate with me at any time I needed help. Some of them continue to send service data and circuits of all the new models as fast as they come out. I did not try RCA; but Victor supplied data and diagrams of all the sets and power packs that they had ever used in their outfits.

So I feel that I, at least one out of the thousands, should come to their rescue and say that if they are approached in the correct manner they will, most all, do the right thing; because they want their goods to stay sold and, once the public gives a manufacturer a bad name, that manufacturer might as well quit. But they feel that they cannot hand out expensive service manuals to every one who writes in for them; for they would then have to supply them to thousands and thousands who have no earthly need for them, but are only eager to see how many they can get and store away like they do the catalogs of the mail order houses.

H. O. BENEFIELD,

*Radio Repair and Construction Co.,  
New Orleans, La.*

## THE SERVICING BUSINESS

*Editor, RADIO-CRAFT:*

I wish to extend my approval to such letters as that of Mr. Golten, of the Stewart-Warner Co., in the May issue of RADIO-CRAFT. As to such letters as that of Mr. Graham, of RCA Victor, it is a crime the way some dealers get by in this city with their squad of bread snappers, who just rush in and change one tube or two and rush out; without even trying the set for volume on one end of the dial, checking the line-voltage, condenser alignment, lightning arrester or antenna. In my first experience with a music house as a Service Man, I was requested to install ten to fifteen antennas a day, and "don't stop till you finish them, either." I did that for \$25 a week, twelve to sixteen hours per day for one season; and every antenna brought the company in ten dollars.

Today, I am doing the work for myself and going after more, starting tomorrow

with a monthly mailing list. I have several good jobs on interference to my credit, and could have more if the people of the vicinity could get enough together to pay for the material. In such cases I help them along by sharing the profits by 5%.

E. A. MATTHIAS,

*Chief Radiotrician, Radio-Craft.*

*1422 Haugh Street, Indianapolis, Ind.*

(Mr. Matthias is in business under the title above given.—*Editor.*)

## A PLEA FOR THE INDEPENDENT

*Editor, RADIO-CRAFT:*

As Mr. Graham says in last month's RADIO-CRAFT: "The fact that no radio manufacturer yet enjoys a popular reputation for excellence of service through his dealers must be due to the relative youth of the radio dealer system"—and that is a reason "for not desiring to support the independent service organization."

Why doesn't the radio manufacturer consider the poor Service Man who has spent his good money for a radio education to perfect his knowledge, because he feels that he can make good in this line and enjoy it; while the radio dealer is not interested in servicing the line of radio he handles, and does not care whether the customer gets service after the set is once sold? Since most radio dealers are men who are not interested in radio, it stands to reason that they do not absorb radio knowledge as well as a young man who is interested in this work.

And why should the manufacturer go to the trouble and expense of preparing a course and organizing dealers, when there are thousands of trained radio Service Men who are willing to, and who need to, work for their support? I hope the manufacturer will soon realize that he cannot run his business without good Service Men to keep his product in satisfactory repair.

I feel sure that if the radio manufacturer would consider the Service Man's situation, he would realize how grateful the latter would be toward him for making arrangements whereby the dealer could entrust all servicing to the independent Service Man.

WILLIAM B. HALE, JR.,

*Sussex, Virginia.*

## A SELLING POINT

*Editor, RADIO-CRAFT:*

I can't for the life of me see why Service Men use so much space, that could be put to good use otherwise, squawking about the manufacturers not furnishing data for their receivers. In nine cases out of ten, if some one asked these Service Men to recommend a receiver, they would name one whose manufacturer furnishes them no data sheets. Why not enter the custom-built field (as salesman) when called to service a set whose manufacturer will furnish no data? Take the receiver to your shop for a complete examination and install your custom-built receiver. Treat your customers to a real radio party; who can tell, you might make a sale?

I would like to get the dope on this short-wave business; is it true, as an article in  
(Continued on page 651)



AMRAD MODEL 81 ("BEL CANTO" SERIES) RECEIVER

The tubes required for this receiver are as follows: V1, V2, V3, '24s; V4, V5, '27s; V6, V7, '45s; V8, '80; V9, 2.5-volt bulb.

R1 is the volume control and varies the voltage applied to the screen-grids of V1, V2, V3.

Further constants for this receiver may be obtained from the following list. C1, C2, C3, C4 constitute the four-gang tuning condenser; C5 has a capacity of .00025-mf. C6, C7, C9, C11, C12, are contained in "by-pass block condenser No. 8113" (which may have either lug or wire terminals, connected as shown in the accompanying illustrations), and the values are: C6, C7, C12, 1.0 mf., C9, C11, 0.5-mf. C8 has a capacity of 1.0 mf.; C10, .002-mf.; C13, 0.25-mf. The four units of the electrolytic condenser have the following ratings (the four terminals are the positive leads and the copper case is the common, grounded, negative side of the circuit): M1, 18 mf., M2, 8 mf., M3, 18 mf., M4, 8 mf.

The resistors have the following values: R1, 50,000 ohms; R2, 21,000 ohms; R3, 1.5 megs.

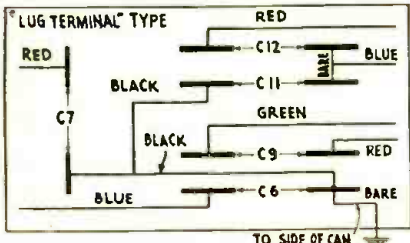

One type of filter-block terminals.

R4, 12,500 ohms; R5, 100,000 ohms; R6, 2,250 ohms; R7, 20 ohms; R8, 200,000 ohms; R9, 5,000 ohms; R10, 60 ohms; R11, 31 ohms; R12, 860 ohms; R13, 1,500 ohms. The resistor cartridges are colored as follows: R2, green; R4, black; R5, yellow; R6, orange; R9, brown; R13, purple.

The Model 81 chassis is fused at three amperes. The "antenna compensating control" is the 10-plate variable condenser marked C1A;

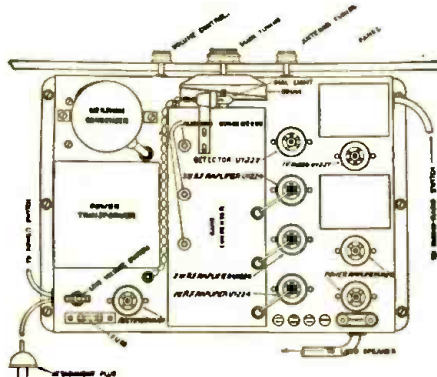

A view looking down on the "81" chassis.

while the remaining trimming condensers are adjustable, through the shield can, with a screwdriver. Binding posts at the rear of the chassis permit selection of the correct tap on the antenna input inductance L1, for the required degree of selectivity and sensitivity. When the tube is renewed at V4, it will probably be necessary to readjust the setting of R8. If circuit oscillation should appear in the receiver, it may usually be traced to a defective '24 tube, which should be replaced.

The cord which operates the tuning dial is kept in tension by an adjustment which compensates for stretching; this is regulated by putting a screwdriver through a hole cut in the edge of the dial drum.

Each of the R.F. transformer primaries (L1, as well as P in L2, L3 and L4) consists of a winding of about 200 turns on a bobbin at the grid end of the secondary; it has a direct-current resistance of about 80 ohms. Ch1 has a resistance of about 100 ohms.

The D.C. resistance values of T1, between ground and the three higher-potential ends, are as follows: to phono tap, 20 ohms; to detector tap, 2,000 ohms; to grid lead, 12,000 ohms. The primary of T2 has a D.C. resistance of 1.600

ohms; the secondary has an over-all resistance value of 10,600 ohms, divided into 4,800 and 5,800 ohms for the grid circuits of V6 and V7. Transformer T3 has a primary D.C. resistance of 190 ohms on one side of the tap, and 220 ohms in the other; the secondary has a D.C. resistance of 0.8-ohm (approx.) to match the voice coil of an RCA "Type 106" dynamic reproducer. The field coil of this instrument has a D.C. resistance of 7000 ohms. As most Service Men know, the voice coil is easily centered by first loosening the center machine screw that clamps the cone-spider to the iron core. (The voice-coil leads of the "106" are marked "B" and the field-coil leads are lettered "C.")

Correct operating conditions for the "Model 81" Amrad are as follows: V1, V2 and V3, plate voltage 180, control-grid bias 1.5, plate current 4 ma.; V4, plate voltage 30 (with tube out of socket, 140 volts), grid bias 0.0, plate current 1.5 ma.; V5, plate voltage 160, plate

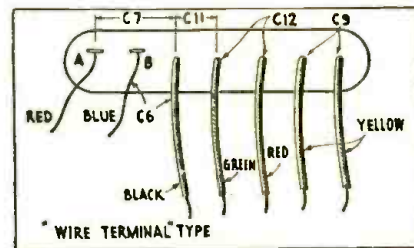

Another form of condenser connections.

current 4.1 ma., grid bias 10.5; V6, plate voltage 250, plate current 28 ma., grid voltage 50, filament voltage 2.25; V7, same; V8, plate output 110 ma., filament voltage 4.65. (All the other tubes have a filament voltage of 2.25; at the socket with the tube out, 2.32.) These values were obtained with the set adjusted for a 120-volt line supply, and the volume control full "on." The "C" bias figure of 10.5 volts for V5 will not be obtained unless the hum control R7 is turned to the ground side.

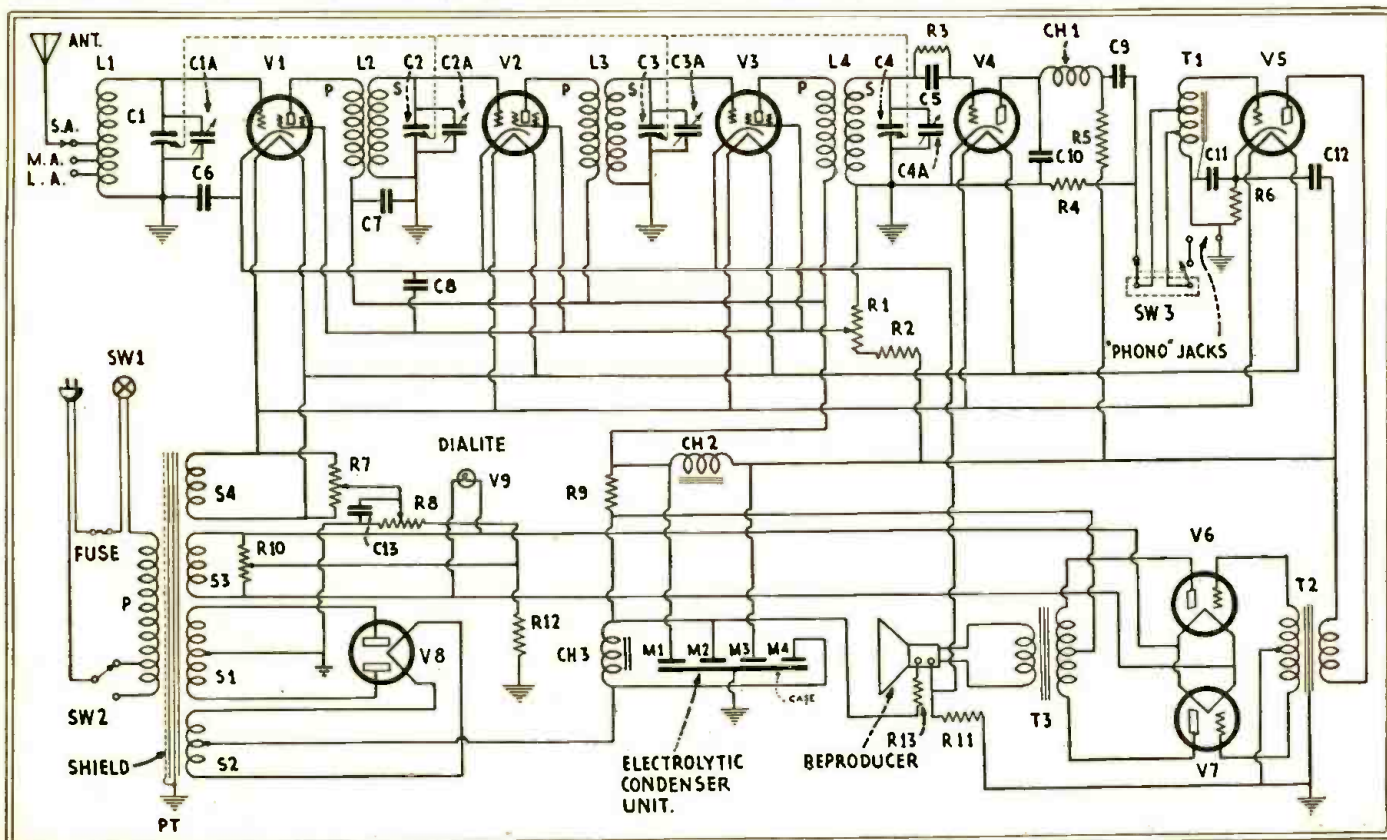



RADIOLAS "SUPER VIII" (AR-810), "SEMI-PORTABLE" (AR-812), 24 AND 26

These four Radiola superheterodynes use the same 6-tube catacomb, the first of this type put on the market by the Radio Corporation of America; differences lie in the mechanical arrangement of the units outside the catacomb, and in the electrical and artistic design.

The "812," to which most of this material specially applies, is an entirely self-contained semi-portable table cabinet set with a battery compartment at each end. The A.F. output is obtained at a jack; a plug-operated switch changes the circuit from one A.F. to two. Another switch controls the "A" circuit. There is a master rheostat ("Battery Setting"), R3 in the diagram on this page, and also a vernier rheostat ("Volume Control") R2; the latter controls I.F. amplifier V3. A fixed loop antenna is located in the rear of the cabinet. Phones or speaker may be used.

The "AR-810" or "Super VIII" has a high-boy cabinet, with a large rotatable loop and a loud speaker. The filament circuit is controlled by a door-operated switch instead of SW1, which is replaced on the panel by a knob that controls the loop.

Radiola 24 is a black-leather-covered portable with a built-in loud speaker and a rotatable loop that fits into the cabinet when not in use on top.

Radiola 26, the well-known portable so often used for locating interference, is extremely compact, includes a loud speaker and batteries, and has a rotatable loop that comprises part of one door. A "home battery box" is used for economical operation at a fixed post. Tip jacks are provided for headphones.

Six UV-99-type (or UX-99s with adapters) tubes are required; to use the UX-20-type tube at V6 an adapter is required (such as the Na-ald "Type 420 Connector") which will permit the '20 to assume the horizontal position necessary in order to close the panel, as well as an additional 45-volt "B" battery and a 22½-volt "C" battery.

To prevent repetition of details, reference should be made to Data Sheet No. 16, "Radiola 25 Superheterodyne," April, 1930, issue of RADIO-CRAFT. The same sequence of signals is followed through the catacomb.

Looking at the rear or catwhisker side of the catacomb, and at the terminal strip, V1 is at the left and V6 at the right.

"Station Selector No. 1" is C1, and "Station Selector No. 2" is C2. The rotor side is indicated below by R.

In certain receivers of the Super-VIII model two loud speakers are used; in others, one. The connections, in the "810," are shown in dotted lines. C13 may have a capacity of about .006-mf.

Arrangement of the tube-socket contact springs is shown at the lower left of the schematic, and the correct connections for the oscillator coils directly above. The numbers on the mounting plate correspond with the circuit connections; if one coil is reversed, the set will be made inoperative.

The loop connects to a terminal board on the back of the cabinet. The normal position for "link" is shown in dotted lines; in the second position shown, an external loop may be led to posts 4 and 2, for increased pick-up or more directional reception. A short antenna may be used on post No. 2 or a longer one on No. 1, with either loop in use. A standard "R.F. transformer" designed for .0005-mf. condensers may be used instead of the primary, and the secondary leads to posts 4 and 2, with "link" open. This is usually unsatisfactory near strong stations. If the location is particularly shielded, good operation can sometimes be obtained by connecting post No. 1 to ground. Any external connection to this terminal board will change slightly the readings of Selector No. 1. A convenient method of obtaining just the right degree of signal input to the set is to make a coil of magnet wire, any size, about 30 to 50 turns hitched, with a diameter of about six inches, and connect it between aerial and ground; this loop is brought as close to the back of the cabinet as necessary for good coupling.

Absence of signal may be due to open loop or broken pigtail on C1. An open loop may be caused by wires twisting loose from the collector rings. Dirty or loose rings may cause noisy operation. (In later sets of the Super VIII flexible leads supersede the collector ring construction.) A rattling sound in the reproducer may be due to the catacomb springs touching the loop shaft.

Wrong jack-switch circuit change may be due to dirty or bent switch springs, or loose knob.

When working properly, distant stations can be heard in either of two positions of C2; local stations may come in at three or four places. A wave trap or relocation of the set may be necessary.

A cause of trouble may be one of the strands of one of the catwhiskers touching either an adjacent terminal lug or grounding to the can.

Occasionally an "oscillating catacomb" will be found, and the only remedy is to change the catacomb; for no manner of adjusting will stop the oscillations, which cause whistles to be heard on all station settings.

If it is necessary to turn R3 up high, even with new batteries, check the tubes and the "C" battery's polarity. (The "C" is at the rear—inside the loop.)

Any tube in sockets V1, V2 or V3 remaining lighted after switch SW1 has been turned to "off" is an indication that the filament is touching the grid. Tube requirements for V2 seem to be more critical than the others, and tubes subnormal in any way will show up markedly in this position. Rearrange tubes with this in mind. Failure of tubes in the Super VIII to light may be due to failure of switch operated by desk-fall to make contact; bend the spring contacts.

Weak or noisy reception, with C1 tuning considerably below C2, may be due to one or more shorted loop turns; inspect loop carefully. Noisy reception may be due to dirty socket springs; clean only with sandpaper and pull up springs. To do this without removing batteries or all tubes necessitates an insulated tool to prevent short circuits. The loop of the Semi-Portable is easily removed for inspection after catacomb, battery cable, by-pass condenser, "C," catch, and handle are out.

Using phones or a meter with a 4½-volt "C" battery, the following table may be used for making continuity tests on the catacomb of Radiola 24, AR-810 and AR-812, without removing it, when the battery cable is disconnected; and tubes are removed:

| From | To                    | Test    |
|------|-----------------------|---------|
| 1    | V1 grid               | Open    |
| 4    | V2 plate              | Closed  |
| 5    | V2 grid               | Closed  |
| 6    | V1 plate              | Open    |
| 6    | V1 grid               | Closed  |
| 6    | V3 grid               | Closed  |
| 6    | V5 grid               | *Closed |
| 6    | V6 grid               | *Closed |
| 7    | V3 F—                 | Closed  |
| 8    | V1, V2, V4, V5, V6 F— | Closed  |
| 10   | V4 plate              | Open    |
| 10   | Catacomb can          | Closed  |
| 10   | All F+                | Closed  |
| 10   | V4 grid               | Open    |
| 11   | V4 plate              | Closed  |
| 12   | Terminal 3            | Closed  |
| 12   | V1 plate              | Closed  |
| 12   | V3 plate              | Closed  |
| 12   | Terminal 14           | Closed  |
| 13   | V5 plate              | Closed  |
| 15   | V6 plate              | Closed  |

\* With headphones, a weak click should be heard.

The figures in the left column refer to the connection lugs on the terminal strip, to which the whiskers of the catacomb are connected; counting from left to right, and looking at the catacomb from the rear.

Catwhisker No. 2 does not appear on the catacomb; and terminal lug No. 2 is not used. Terminal connection No. 9 does not connect to the catacomb, nor No. 16; their connections to parts outside are shown.

To replace C12, a fixed .0001-mf. unit will usually serve. The value of C10 is .006-mf. C11 (rear of cabinet) may be replaced with a 1.0 or 2-mf. unit.

The catacomb of Radiola 26 is mounted differently, and the connections thereto are reversed. As a stage-change switch is not used, the built-in loud speaker is at all times connected to the second audio stage, and the phone-tip jacks to the first stage.

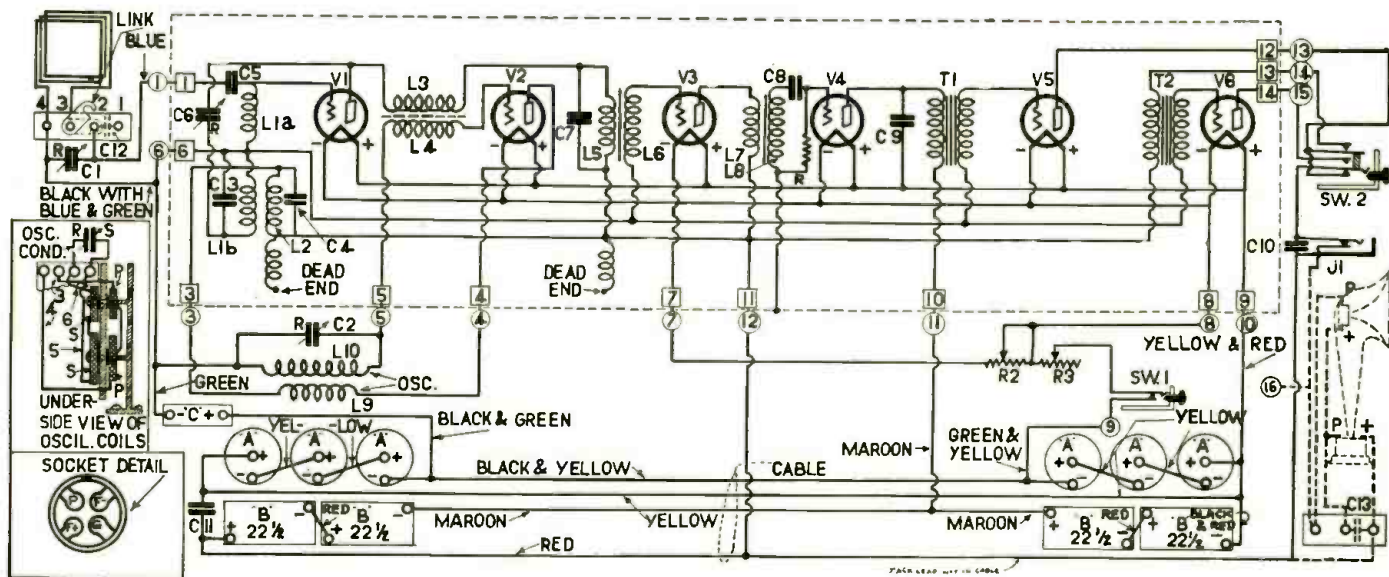

Above "Socket Detail" at lower lower left, the oscillator coils, their terminal strip, and C2; upper left, loop connections; lower right, "Super VIII" speaker connections. All "F+" leads (9-10) ground to can. Lead to center spring of J1 jumps over lower (sleeve), or "B+" contact. C6, within "cat," comes adjusted for average '99s. Numbers in squares refer to catwhiskers; in circles, to terminal lugs. Loop has 14 turns of No. 18 wire, spaced 3/16-in., on a frame 9" x 18½". Batteries are in position for the "812."



# Educating A Service Organization

## A Letter to RADIO-CRAFT Describing a Well-Planned Campaign of Field Activities

By H. C. GRUBBS

Vice-President, RCA Victor Company, Inc.

I HAVE read, with a great deal of interest, Mr. Gernsback's editorial "Frenzied Radio" in the February issue. The Victor service policy has been directly opposed to what you have indicated as the general attitude of the radio manufacturer toward its product after sale. Victor is not only interested in the sale of its products, but is vitally concerned that each owner of a Victor instrument derive the uninterrupted enjoyment to which his purchase has entitled him.

Our guarantee is not limited as to time, but is based upon the policy that any unit becoming inoperative as a result of defective material or workmanship will be replaced without charge to the customer. In addition to furnishing the replacement part, we assume the expense of making the installation.

Regardless of how well a radio receiver may have been manufactured, its initial performance will depend entirely upon the character of its installation in the home, and upon the grade of accessories, such as tubes, with which it is equipped. It may also be subjected to many conditions entirely beyond the control of the manufacturer, such as abnormal line-voltage conditions, rough usage,

etc., which result in requests for service.

Although the actual servicing of the radio in the home is definitely a function of the dealer, we have not permitted him to shoulder this responsibility unassisted. This department maintains a staff of technical representatives, one of which is assigned to each distributing zone and whose duties are as follows:

Assisting in the organizing and development of the distributor's service department; instructing the personnel of the distributor's service department in the servicing of all Victor products; assisting the distributor's service department in developing dealer's service facilities; generally assisting the service departments of both distributor and dealer in any special service problems which may arise from time to time.

A group of factory Service Men is stationed at each distributing point to assist distributors with dealer service work.

In addition, this department issues service bulletins from time to time on the testing and servicing of Victor products, which are mailed direct to all Victor dealers and jobbers as well as to individual Service

Men who request copies. We also issue monthly to the trade a publication, "Victor Service," which is devoted entirely to service.

We are now conducting a gigantic service campaign in a number of metropolitan areas, whereby factory service is being carried directly into thousands of customers' homes. The working plan is as follows: a list of customers' names is obtained from dealers in the various cities where this activity has been scheduled. A personal letter is sent to these owners by our sales manager, pointing out that we are interested in knowing that each Victor radio in use is providing the greatest possible enjoyment, as well as complete satisfaction, and that, if such is not the case, a factory service representative will be sent to his home to make any necessary adjustment. The results afforded by this campaign, to date, have been most gratifying, and have surpassed our expectations.

I do not believe that you will have any difficulty in realizing from the above that Victor is not in your general classification of manufacturers who are not interested in service.

### VICTOR SERVICE

## A Few Words to the Serviceman About the Customer

**THE** conduct of the serviceman in the customer's home is a subject which has at one time or another been the cause of concern on the part of practically every dealer. Through the experience of many years, Victor has found a number of points which are of utmost importance in governing the serviceman's actions in the customer's home. We give them to you here, not as a how-to-covered assignment lecture, but merely for what they may be worth to you.

**Sell Yourself on the Product**  
Your job as a serviceman is to keep the instrument in perfect operating condition and to keep the customer in a satisfied and happy state of mind. To do this successfully, you must be as thoroughly sold on the product yourself as the salesman who will make the sale. You cannot otherwise expect to win the confidence of the customer in the out into the Trade and radiate confidence in the machine and optimism in regard to its performance. Study and learn all you can about the Victor Radio so that you will understand and appreciate all of its superiorities.

**Appearance**  
In addition to technical and sales ability, one of the first requisites of a good serviceman is that he have a neat personal appearance. A clean-shaven, neatly-dressed man will always make a good first impression upon the customer. The serviceman should be a practical technician and not a mechanic; he should dress accordingly.

**General Conduct**  
In your contacts with the customer always be courteous, but also be cautious. Do not say anything which may reflect upon your employer. Remember that there are always two sides to every story, and that you should not be influenced by the customer's viewpoint to the extent of overlooking the policies of your store. On the other hand, it should be remembered that one of the first elementary principles of salesmanship is that the customer is always right. Of course, you will not agree with him at all times in your own mind, and it is then that he should be shown, not through argument, but through constructive explanation, that he has been misinformed.

**Working Procedure**  
When working on an instrument, it should be unnecessary to speed its parts or your tools over the floor. This creates an unfavorable reaction and tends to make the customer feel that his machine, since it is a repaired one, will never be equal to a new one. It would be far more desirable to make him feel that the repair was extremely simple, for he will then have confidence in the machine after you have adjusted it, knowing that the difficulty which caused the improper performance was of a minor nature.

Should you find it necessary to use a protective cloth, use a number of tools, place a protective cloth on the floor where the work is being done. You are of the opinion that this added precaution is essential, but remember that a careful, neatly-dressed man in doing a good job will help you measure in establishing yourself with the customer as a reliable and efficient serviceman.

Many people object to smoking; do not smoke while working in the customer's home unless you do so.

**Explain Replacements**  
If you replace a chassis, amplifier or other unit, explain to the customer the fact that the unit is purposely constructed so that it is interchangeable and can be replaced without the need of repairs in the home. Just as sure as you explain this to the customer, he will be satisfied and will say "The radio was so badly broken that it had to be replaced."

**Customer Instruction**  
After you have adjusted the instrument, instruct the customer carefully. Explain the importance of controlling volume with the volume knob, and the importance of all points about the operation of the instrument without the aid of a manual. Radio installations without the aid of a manual are almost always a needless service call.

Another article for the serviceman, with the customer and the dealer, is the issue of VICTOR SERVICE.

## VICTOR SERVICE

*"Efficient Service—the Victor Dealer's Greatest Advertising Medium"*

VOL. I      FEBRUARY, 1930      NO. 3

### Service and the Serviceman

**M**OST dealers are always on the lookout for ways of making improvements in their business to increase sales. When confronted with the problem of service, they naturally want to know how better service and a high-class service man will pay dividends in the form of new business. The answer to this question is a generally recognized fact which has been proven in any number of cases: Adequate service for the customer will establish greater confidence in the reliability of the dealer and customer relations must necessarily come from this source.

Through service and the serviceman you drive home the value of a Victor Radio to the customer. He will be your friend and a real asset to your store.

Adequate service means to the first place a good installation, and secondly, a genuine interest in the operation of the machine, backed by an active willingness to make prompt adjustments to meet conditions which might arise. The performance of a Victor Radio, your friend, and being considerate of its needs so that it will work for you.

This important work of keeping the Victor Radio of your best business friend in the best of repair is entrusted to your serviceman. It is his job to inspect the instrument before it goes on the sales floor, for it may otherwise cause the loss of a sale and discourage a good salesman. After it is sold, if the customer has difficulty with the operation or maintenance of it, it is the serviceman who will attend to it. When, after a period of use, the radio needs inspection, it is again the job for the serviceman to place on the sales floor, in through its life and working for you. The serviceman is an important part of your organization; you will want to be careful in his selection and training.

To rate the average serviceman as in any way a not care to trust such an important matter as a sale to him. This may be correct in some cases, but when the customer is complaining that his radio will not operate, that he will not pay for it, and that you must send for it, whom do you send to make it perform properly, to smooth out the customer, and to make him happy again? Isn't there real salesmanship in a job well done like that? You know there is.

You may ask, "What makes a good serviceman?" The definition given by one great manufacturer is that he must be a man of patience, tact, courtesy, good personal appearance and bearing, and have a liking for mechanical and electrical things. Another man who has made a striking success of service, says that the serviceman must be the best common sense mechanic, and select your serviceman accordingly. Pick a bright conscientious man of this type for the job, and you will find that he is neither because he knows the product and can meet people. Then work him along and get another one. The growth of your business will warrant it, for he will have made the Victor Radio friendly to you and working for you.



Each issue of VICTOR SERVICE contains valuable news which you will need later on. The spring clamp binder illustrated above is recommended for convenient filing of your copies. This binder is leather-bound, 122 pages, and is available from Shiley, 122 N. Third St., Camden, N. J., at \$1.45 postpaid. Shipment will be made upon receipt of check or money order.

**Don't slight the installation during National Profit Building Campaign**

The pages of the RCA Victor monthly trade publication, mentioned by Mr. Grubbs, contain advice to dealers and Service Men; a couple of them are reproduced above, reduced about one-half.



# Servicing With a Set Analyzer

*The design and connections of a very popular set analyzer and tube tester, using two precision meters in a versatile manner with the aid of numerous resistors and push button switches.*

By JOHN M. FORSHAY

*Service Representative, Jewell Electrical Instrument Co.*

**A**N assortment of meters, or their electrical equivalent, is a necessity for successful servicing. The day when even a good Service Man determined voltages by the brilliancy of tubes and the amount of shock felt by touching high-voltage leads, or the extent of the arc caused by breaking a short-circuit, is far in the past.

We describe below a commercially practicable service instrument; the Jewell "Model 199" set analyzer, which weighs only 7 lbs. Fig. A is a front view, showing an excellent example of the compact design possible, and desirable, in equipment designed to accomplish a number of purposes with a minimum of weight and size. This has been made possible by calibrating one D.C. and one A.C. meter for a great number of scales, as follows: the A.C. voltmeter VM, a special Jewell "Pattern No. 74," has scales reading 0-4-8-16-160 volts. The "1,000-ohms-per-volt" D.C. instrument VM-MA, a special Jewell "Pattern No. 51," is calibrated in volts and milliamperes to read 0-6-30-60-120-300-600-volts, or 0-12-60-300 milliamps. Push buttons change the connections to afford automatically any of the numerous circuit arrangements possible with meters of the ranges specified above.

### Extension Accessories

To make these tests it is necessary to have special test leads and adapters; a list of those which complete the Analyzer, as shown in Fig. A, are as follows: 1, "No. 8176" cord assembly, is a 54-inch length of double-strand lamp cord, terminated at one end by a light-socket plug and at the other by insulated phone tips; 2 is a pair (one black and one red) of "No. 9018" test leads, of similar length, with 6-inch insulated test prods at one end and spade terminals at the other; 3 is a "No. 8813" 7-inch screen-grid lead for connecting to the cap of a '22 or '24 tube; 4 is a "No. 8684" 5-hole, 4-prong adapter for all UX sockets; 5 is a "No. 8173" 5-hole, 4-prong adapter (green ring with shell and bayonet) for UV as well as UX sockets; 6 is a "No. 8111" 4-hole, 5-prong adapter (red ring); 7 is a "No. 8927"

42-inch screen-grid lead for connection to the lead in the receiver that normally clips to the screen-grid cap; 8 is a 36-inch cord, terminated by a plug which connects the receiver under test, through any socket, to the analyzer. At 9 is a 4½-volt battery used for testing the characteristics of tubes, resistance and capacity value determinations, and for continuity testing.

Just what is the comparison between servicing without an adequate meter combination, and servicing with a few meters that carry a number of calibrations?

To answer this question, let us now revert to the pet equipment of the Service Man of yesterday. Test prods, a single headphone, an old and decrepit "C" battery, a 0-7½-150-volt D.C. meter, and the usual tool necessities completed the kit.

The use of this earlier type of kit was, within certain limits, a satisfactory means of testing—at that time. Radio sets of today demand a different test procedure. Mr. Set Owner has been educated to a realization of what to expect from his radio, and half-repairs don't "go" anymore. Leaky condensers, weak tubes, line-voltage variations, shorted turns, wrong condenser values, off-center resistor and inductance taps, incorrect resistor values must be detected; open-circuit and load voltages must be compared; noisy current supply must be checked. These and many more facts must be determined and remedied if the Service Man is to be a

success; and if the service organization is to operate with minimum expense; since it is the return call that eats up the profit. The old hit-or-miss testing method that must be followed when inadequate, inaccurate meters are used, is inadequate for thorough servicing.

It must be remembered that servicing does not mean merely putting a tube into a tube tester to check its condition, reading supply voltages, and listening to the reproduction. What did the last Service Man on the job do to the set? Perhaps he shorted out a unit, or put in one of wrong value. Superficial testing does not show up, as will time, such faults, as are being caused, day after day, by a certain type of so-called Service Men.

Obviously, the man on foot cannot load himself with anything but the bare necessities of his trade; and for the Service Man the utility of four, and more, meters has been concentrated in the instrument that has become known nationally as an "analyzer."

### Circuit Controls

Fig. 1 is the schematic circuit of one model of the "199," (pictured in Figs. A and B). A slightly later model has been designed to include a four-post A.C. meter, instead of the two-post connections shown, which enables voltages up to 800 to be read; and an extra button has been included to provide a 50-ohm shunt across the D.C. meter and

Fig. A

Right, the well-known Jewell "Model 199," whose readings are given as standard by many manufacturers in their service manuals. The figures are explained in the text. A number also of special (extra) accessories are available to increase the usefulness of the Analyzer for laboratory use. The carrying case is 12 x 9 inches, 4 inches deep.

Fig. B

Below, the "works" of the "199" from the under side of the panel; the wiring is cabled, and switches cased.

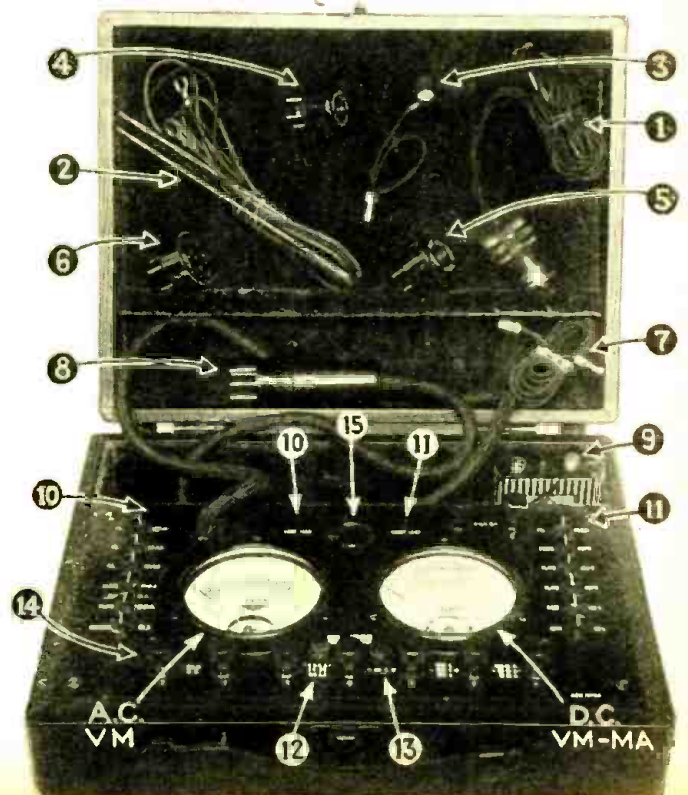
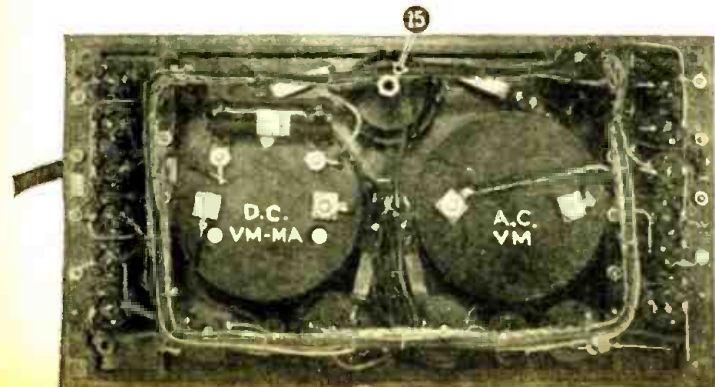



give a 0-6 ma. reading on this meter. Fig. 2 is a parts layout of the earlier model in which button-controlled switches have been given reference numbers, and the binding posts and screen-grid taps have been given reference letters. "Cable" is the article marked 8 in Fig. A, which connects to "plug" in the schematic circuit.

Running through the possible tests with the analyzer, we segregate these as follows: pushing the buttons in numerical sequence:

No. 1, for 1.5-, 2.5-volt filament tests on type '26, '27, '24 and '45 tubes.

No. 2, for 5- and 7.5-volt filament tests on type '71, '80, '81, '10 and '50 tubes.

No. 3, for 15-volt (Arcturus) tube filaments.

Nos. 4 and 5 are used for determining plate currents; they are pressed at one time for plate currents over 60 and up to 300 milliamperes—values usually found as rectifier-tube current outputs.

**Reversing Polarities**

No. 6 is pressed to determine cathode-bias voltages. This is accomplished either with or without the use of button 14 (which reverses the meter connections for reversed polarity of the cathode). No. 6 without 14 will indicate a negative potential on the cathode.

No. 7 is used to measure the exact D.C. voltage applied to tube filaments where it does not exceed 6; as when '01A, '99, '12, '20, or '71A tubes are being used in the set. Of course, any other tubes working on D.C. within these limits may be measured. If the filaments are wired in reverse positions (for instance, in the earlier Radiola superheterodynes) it will be necessary to use the reversing switch 14.

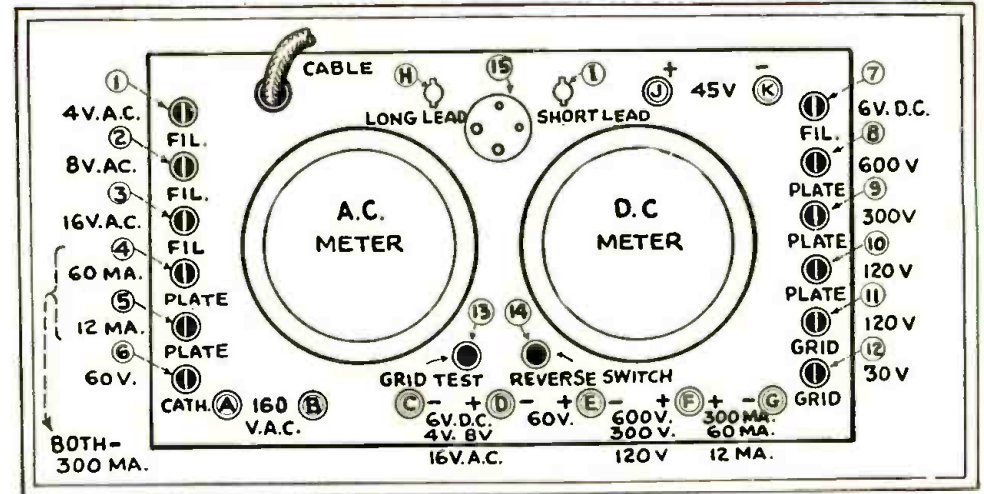

Fig. 2  
Appearance of the panel of the Analyzer with a UX adapter in the UY socket (15). The A.C. meter has four scale calibrations; the D.C. meter three.

No. 8 is used to measure plate potentials up to 600 volts. Before pressing this button when a rectifier tube is in the analyzer, it will be necessary to make certain that No. 14 has been depressed; because the current travels in the reverse direction through such tubes, and the filament will be on the positive side of the output voltage. Unless button 14 is first depressed, the needle of the meter may be damaged.

Nos. 9 and 10 are for plate voltages of lower value.

Nos. 11 and 12 are for grid biases, as well as determining screen-grid potentials. In testing screen-grid tubes the screen-grid voltage must be measured *before* the cable terminals are inserted in H and I and (since this is a positive value) button 14 must be

depressed at the same time. This is the only value to be taken on this tube until leads H and I are inserted in their proper places; then the other values may be taken as in any other tube of which it is desired to learn the control-grid, filament, and plate voltages and currents. (In the latest model, previously referred to, a 6 ma. push button, below the position of No. 12, has been incorporated for determining the screen-grid current. The position of the 50-ohm shunt is indicated in dotted lines in the schematic circuit.)

**Testing Tube Efficiency**

No. 13 controls a tube-testing device used in connection with any of the plate ma. buttons selected for the particular tube. The plate current is read; with the Ma. button still held down, No. 13 is depressed and the second value of plate current is noted. This change is approximately in proportion to the condition of the tube. These changes have been recorded in the very complete testing manual that accompanies each instrument, and are reproduced herewith:

Types WD-11 and 12, plate voltage 22.5 to 45, change 1.50; 67.5 volts, 1.58; 90 volts, 1.90. Types UV- and UX-'99, plate voltage 22.5 to 45 volts, change 1.40; 67.5 volts, 1.67; 90 volts, 1.83. Type '12A, 90 volts, change 6.60; 135 volts, 7.40; 157 to 180 volts, 7.48. Type '20, 90 volts, change 1.88; 135 volts, 2.20. Type '71A, 90 volts, change 5.28; 135 volts, 5.98; 157 to 180 volts, 6.38. Type '00A, 22.5 to 45 volts, change 2.95. Type '01A, 22.5 to 45 volts, change 1.90; 67.5 volts, 2.50; 90 volts, 3.20; 135 volts, 3.35. Type '10, 157 to 180 volts, 4.84; 250 volts, 5.86; 350 volts, 6.60; 425 volts, 6.82. Type '22, 67.5 volts, 1.14; 90 volts, 1.18; 135 volts, 1.23. Type '24, 135 volts, 2.5; 157 to 180 volts, 3.0. Type '26, 90 volts, 3.83; 135 volts, 3.83; 157 to 180 volts, 3.83. Type '27, 90 volts, 3.19; 135 volts, 3.60; 157 to 180 volts, 3.83. Type '40, 90 volts, 0.88; 135 volts, 0.88; 157 to 180 volts, 0.88. Type '45, 157 to 180 volts, 8.00; 250 volts, 8.00. Type '50, 250 volts, 7.35; 350 volts, 9.35; 425 volts, 10.58.

No. 14, the double-pole double-throw polarity-reversing switch which changes over the meter connections for any reading, may be used (in addition to the tests mentioned above) when leads are connected to the external binding posts provided.

(Continued on page 650)

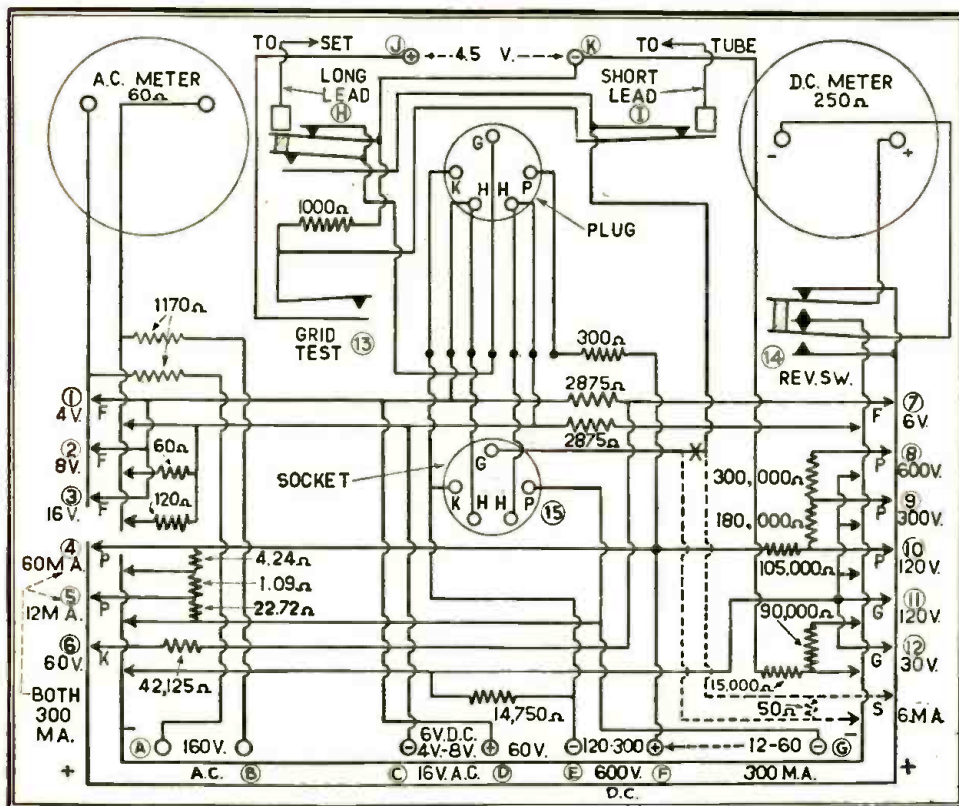

Fig. 1

Schematic circuit of the "199" Analyzer; later models with an 800-volt tap utilize a different A.C. meter. The push-button switches may be locked in their closed positions.



# Men Who Have Made Radio-Frank Conrad

THE NINTH OF A SERIES

“**A**MATEUR” does not imply that the bearer of this title is a newcomer or unskilled in his favorite field of activity; he may be a veteran and a master of his chosen art. Young or old, master or tyro, he is one who works for the pure love of doing things to the best of his ability, because he has within him an urge for action that must find expression.

The subject of this month's cover of *RADIO-CRAFT* is a man whose professional activities for forty years have been prolific with important inventions; yet all of them put together have not had so astonishing an influence upon the daily habits, and even the thoughts, of the human race, as the infection of his amateur zeal for radio.

Frank Conrad has risen from a shop bench to a commanding position among electrical engineers by the exercise of extraordinary natural ability and ingenuity; he grew up with electricity in the days of its earlier commercial application, when everything needful had to be invented while the process of manufacture was being worked out. He was active in the conception and design of equipment for arc-lamp operation, alternating-current power relays and voltage regulators, rectifiers, automotive ignition, starting and lighting equipment, and the ubiquitous electric wattmeter. His more than two



hundred patents cover almost every form of electrical appliance. This versatility in his position, that of assistant chief engineer to the Westinghouse Company, has won what might be called a roving license; and the latitude granted him in his work has led to

that wonderful development of radio broadcasting in which he was the successful pioneer.

Radio was already well established as “wireless,” the art and mystery of a select body of telegraphic operators, when Conrad entered into it as one of the numerous, unsung amateurs. His interest, it is related, began in a trifling incident; an argument as to the respective accuracy of watches (another of his many hobbies) led him to establish a small home receiving station for time signals. It was not long before the upper story of the Conrad garage became an amateur “shack,” where many radio novelties were being tested and devised.

The war came; and like other leaders of his profession, he devoted all his time and ingenuity to its pressing problems. The radio services of both army and navy acknowledge his many contributions to their technical demands; in fact, instruments of Conrad's design, for both transmission and reception, were the only radio equipment to reach the front of the A. E. F. in considerable quantities.

With the return of peace, his radio enthusiasm was not demobilized. In his home at Wilkensburg, Pa., near Pittsburgh, he carried on his amateur activities, seeking to  
*(Continued on page 656)*

## Attention: Radio Service Men

**R**ADIO-CRAFT is compiling an international list of names of qualified service men throughout the United States and Canada, as well as in foreign countries.

This list, which RADIO-CRAFT is trying to make the most complete one in the world, will be a connecting link between the radio manufacturer and the radio service man.

RADIO-CRAFT is continuously being solicited by radio manufacturers for the names of competent service men; and it is for this purpose only that this list is being compiled. There is no charge for this service to either radio service men or radio manufacturers.

We are hereby asking every reader of RADIO-CRAFT who is a professional service man to fill out the blank printed on this page or (if he prefers not to cut the page of this magazine) to put the same information on his letterhead or that of his firm, and send it in to RADIO-CRAFT. The data thus obtained will be arranged in systematic form and will constitute an official list of radio service men, throughout the United States and foreign countries, available to radio manufacturers. This list makes possible increased cooperation for the benefit of the industry and all concerned in the betterment of the radio trade.

### NATIONAL LIST OF SERVICE MEN.

c/o RADIO-CRAFT, 98 Park Place, New York, N. Y.

Please enter the undersigned in the files of your National List of Radio Service Men. My qualifications are as set forth below:

Name (please print) .....

Address .....

(City)

(State)

Firm Name and Address .....

*(If in business for self, please so state)*

Age ..... Years' Experience in Radio Construction? .....

Years in Professional Servicing? .....

Have You Agency for Commercial Sets? ..... (What Makes?) .....

What Tubes Do You Recommend? .....

Custom Builder ..... (What Specialties?) .....

Study Courses Taken in Radio Work from Following Institutions .....

Specialized in Servicing Following Makes .....

What Testing Equipment Do You Own? .....

What Other Trades or Professions? .....

Educational and Other Qualifications? .....

Comments .....

(JUNE)

(Signed) .....



# How Tests of Audio Quality Are Made

An explanation of the technical problems involved in the development of audio amplifiers and reproducers, and of the apparatus used in making tests

By LAURENCE M. COCKADAY

**W**HAT is the function of a reproducer?" The answer is simple: "It must faithfully convert, into sound, the electrical impulses passed into it from the output amplifying tube."

Unfortunately this is more easily said than done. The vision is easier than the achievement; particularly so, when the range of the device is as great as that required of the average loud speaker. Bear in mind that the frequency requirements are from 30 to at least 8,000 cycles, and that is a wide band.

At that, for quality reproduction, the magnitude of the frequency band is not the all-important consideration. The relative response at the frequencies within this band is of even greater import. The perfect speaker must have a flat response curve; that is to say, the sound pressure, due to the moving air column set into motion by the vibrating speaker diaphragm, should be equal at all frequencies for a uniform electrical signal input to the speaker windings. With fidelity in audio reproduction the prime requisite in radio receivers, the loud speaker plays a tremendously important role.

### What Makes "Quality?"

The improvement of the loud speaker is not solely in the widening of the frequency operating band, but also in the attainment of more uniform response. The significance of uniform response is more easily explained

**Fig. A**  
A new "power" piano, encased in a sound-proof casket; inside it are specially-arranged microphones to pick up the sound. Through an amplifier, and reproducers, these sounds may be magnified until the pianist can dominate a full orchestra in crescendo. Mr. Cockaday, who is associated with a group of engineers in working out this problem for the Steinways, is seated at the pianoforte.



by an analysis of the distribution of energy between the fundamental and the harmonic frequencies of notes played on various instruments, and also by an analysis of the overtone characteristics of musical instruments. The higher the pitch at which the instrument is played, the less its harmonics. The low notes on the piano are very rich in overtones, but the higher tones are not nearly so. The table shown below indicates the distribution of energy among the fundamental and harmonic frequencies of a note played on the piano, harp and violin.

|            | Harmonic (Per Cent.) |      |      |      |
|------------|----------------------|------|------|------|
| Instrument | 1st                  | 2nd  | 3rd  | 4th  |
| Piano      | 100                  | 99.7 | 8.9  | 2.3  |
| Harp       | 100                  | 81.2 | 56.1 | 31.0 |
| Violin     | 100                  | 25.0 | 11.0 | 6.0  |

A study of this table shows how important it is to use a speaker which has a response curve with the closest approach to uniform amplitude. If, for example, one

considers the piano, we note that the intensity of the second harmonic is practically equivalent to that of the first harmonic or "fundamental." On the other hand, we note that the third harmonic possesses an energy intensity of only about 9 per cent. of the fundamental, and the 4th harmonic not above 2.5 per cent. In direct contrast to this, we find the energy distribution of the third harmonic of a note played on the harp is approximately 56 per cent., and the energy distribution of the fourth harmonic is approximately 31.5 per cent. If the speaker is of such design that it possesses a response curve resembling a cross-section of the Rocky Mountains, with a multitude of peaks on various frequencies, it is possible that some of these resonant peaks are located on such frequencies that they would accentuate certain overtones of the piano note; with the result that the tone quality of the piano would be lost and the instrument, when heard through the loud speaker, would sound more like a harp. (In all these considerations it has been assumed that a well-designed audio amplifier is used.)

The cone and the exponential horn were great improvements on previous reproducers. Both had increased operating ranges and better response curves than the earlier instruments.

### How Response Curves Are Made

While we are on the subject of response curves it would be advisable to digress and glance through the rapid developments in methods of obtaining these curves; for this will throw much light on the advance in reproducing devices during the last few years.

When we say a certain speaker responds to a "wide band of frequencies," just what is meant? How do we know just what frequencies any loud speaker will reproduce? De we guess at it, or listen to it? Is it possible to measure the output? If so, can there be any "best" ways to make the measurement?

Here are some questions that would stump almost any radio or acoustical engineer of only a decade or so back; and there may be, relatively, but a few Service Men to-day who can answer them satisfactorily. To

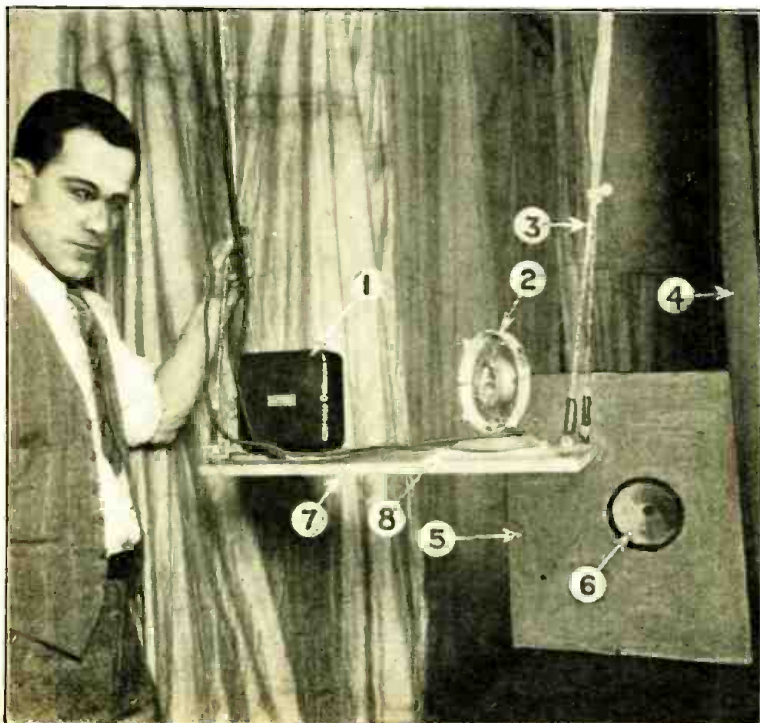

**Fig. B**  
A soundproof room for testing reproducers, with a special calibrated condenser microphone (1) and a standard broadcast microphone (2), the latter used for monitoring purposes, is connected by wire to the measurement booth, elsewhere in the building. The seeing cables (3) by permitting motion of the apparatus prevent possible errors from standing waves; the walls are heavily draped with felt and other soundproof material (4). The baffle (5) houses the speaker (6) under test. The microphones are insulated from the platform (7) by sponge-rubber buffers (8).



answer correctly clients' questions regarding reproducers, and the characteristics of reproducers, it would probably be helpful to know exactly how reproducers can be measured, and the various methods that are being used for determining their response at various frequencies.

There are three general methods employed for this: first, comparison by ear at a number of single frequencies over the whole audio-frequency spectrum; second, actual measurements of the relative response at single frequencies, by means of a special set-up; and third, measurements that determine the total sound-pressure energies released by the reproducer at single frequencies over the whole range. These are the only ways that have ever been used to determine the characteristics of loud speakers, and I have mentioned them in an order that is chronological.

**The Ear Method**

The first method employed, and the one still used the most by acoustical experts, is simply listening by ear. It takes many years

panying ear-response curve (Fig. 1) will show that the human ear is not a "straight-line" device. It takes an enormous amount of energy to create audible sounds, except over a small frequency band approximately between 400 and 4,000 cycles.

How, then, is this method to be relied upon? The answer is, it isn't! It is used with only reasonable success, as a check, by those expert enough—those who know of the vagaries of the human organ of hearing and can place on what they actually hear a value that corresponds with what they have observed while checking up their own aural deficiencies with carefully-calibrated apparatus. When used in this way, the ear becomes a quick and (only reasonably) good method as a check on development of new reproducing apparatus.

But in the old days, when there was no check, the ear was allowed to run wild; and loud speakers were considered good when they had wide gaps in their curves of response, and fell way off at both ends of the frequency scale. To demonstrate this, I have asked a number of subjects

when asked to identify a 10,000-cycle note. So, it can be readily seen that the untrained ear cannot be at all relied upon; and the trained ear, with certain reservations and with frequent check-up by known frequency standards, gives only a reasonable clue to loud-speaker performance.

**Relative Energy Method**

The second method, that of making relative energy tests of reproducers at single frequencies, gives much better general results, and it is by tests of this type that the present improvements in loud-speaker design, mentioned briefly in last month's article, have been accomplished.

The general systems employed, now quite widely, to check up on newer types of reproducers in the laboratory, follow this order: the loud speaker is placed in a well-damped sound-tunnel, or room, in which sound reflection and reverberation have been reduced to a minimum. This is done by covering the walls and the floor and ceiling with sound-absorbing draperies, or other material of a like nature. In this room there is also placed a carefully-calibrated microphone of the condenser type.

In some other location, remote from the influence of the sound room, there is placed an audio oscillator, which is calibrated in frequency and can be adjusted to a known level of output energy. It is also essential, either that this oscillator, which is to generate the single frequencies used in the test, be incapable of producing "harmonics," or that some means of watching for and eliminating harmonics is provided, if the resultant curves on the unit under test are really to mean anything.

The single-frequency electric currents are then fed through a "non-attenuating cable," carefully shielded, to the loud speaker under test. The response is picked up by the microphone and sent out through another cable, also carefully shielded from the first one, to an amplifier which has accurate straight-line-frequency characteristics.

**Recording the Results**

The output energy from this amplifier is then recorded on sensitive electrical instruments; the values are finally plotted and



**Fig. E**

A giant dynamic unit, capable of handling 30,000 milliwatts undistorted output; weight 20 pounds, field current one ampere at 6 volts.

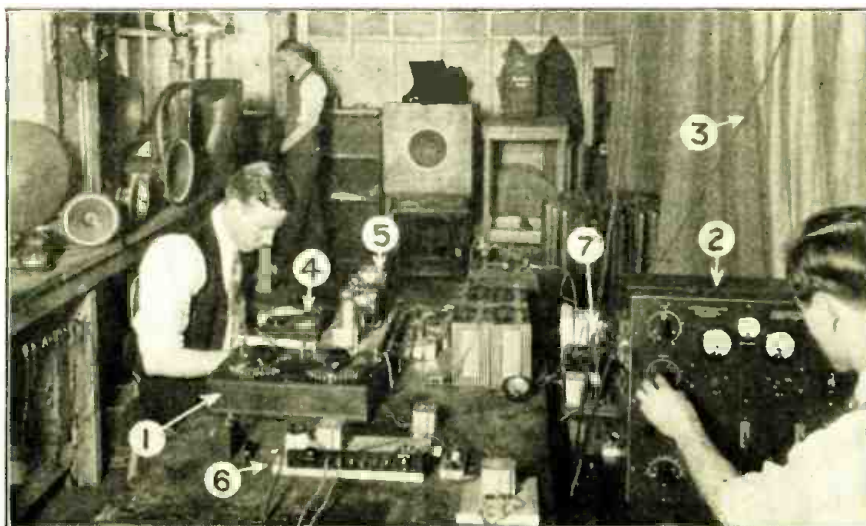

**Fig. F**

An exponential horn for public-address and airplane-speaker work, which is connected to four dynamic units at once. The horn is 59 inches long, 29 inches across the bell, and weighs 28 pounds.

of training to do this well however; and the engineers who are able to do it must check up on their own sense of hearing, every so often, to be sure that they are not drifting into errors which might be enormous. And there are some ears (by far the majority) that are never able to make such a determination with anything like reasonable accuracy. An examination of the accom-

chosen at random to pick out a 60-cycle note from a carefully calibrated record, while it was being played; in most cases the frequency chosen by the listener's ear, was more nearly in the region of 200 or 300 cycles than 60. Similarly, ordinary listeners make mistakes in the higher frequencies, and most of them will pick out sounds in the neighborhood of 3,000 to 6,000 cycles,



**Fig. C**

The generation of sine-wave audio oscillations for testing reproducers: 1, input control; 2, audio oscillator; 3, soundproof wall; 4, input meter; 5, straight-line frequency amplifier; 6, matching transformers; 7, monitoring amplifier. Standard-frequency records (5 in Fig. D) are used.

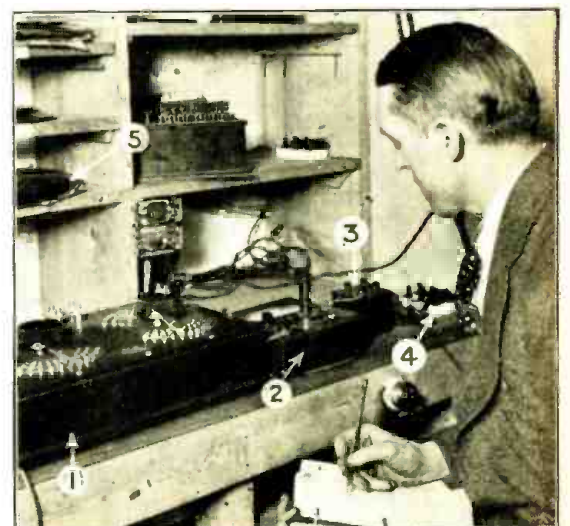

**Fig. D**

Recording the output response: 1, attenuation control, calibrated in decibels; 2, microammeter; 3, thermocouple connected to microphone output; 4, protective line-switch.



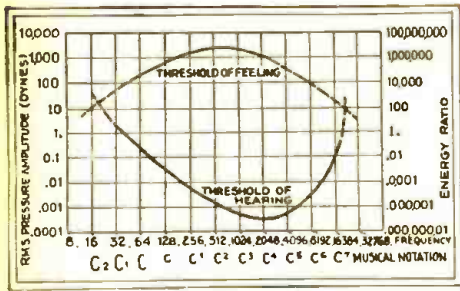

Fig. 1

The characteristic curve of the human ear (the lower heavy line) in this logarithmic graph shows that we have very poor natural acoustic apparatus. The upper curve shows pressures which can be felt, even though not heard.

the various points of the curve lined up on logarithmic "graph" paper. The curve finally obtained, after some corrections for known faults in the circuit, represents the relative amplitudes of the response of the loud speaker at each of the various frequencies over the entire range. This test does not give the true or absolute efficiency of the loud speaker; as it does not represent all of the energy given off by the speaker, but only the part that finds its way, in the form of sound waves, to the microphone. But this test is the best available for the average developmental laboratory and, as I said before, is responsible for the newer and better types of speakers now on the market and soon coming into use. Of course engineers can, by this method, tell when they have made improvements either in the over-all efficiency or in the efficiency of response at any particular frequency. This can be done by comparison with the results from an earlier type, measured on the same set-up.

Sound-Pressure Measurements

The third method, the sound-pressure method, the details of which are not avail-

able for publication, is very complicated and is used, to my knowledge, by only two or three research organizations in the United States; the General Electric and the Bell Telephone Laboratories, at least. However, the actual working out of the various attempts still leaves something to be done with this method; for the orders of efficiency that I have seen, do not even closely compare with each other, for the same types of reproducers.

The descriptions given above should, however, enable the Service Man to understand better the problems of determining loud-speaker characteristics, so that he will be able to explain more readily to his clients

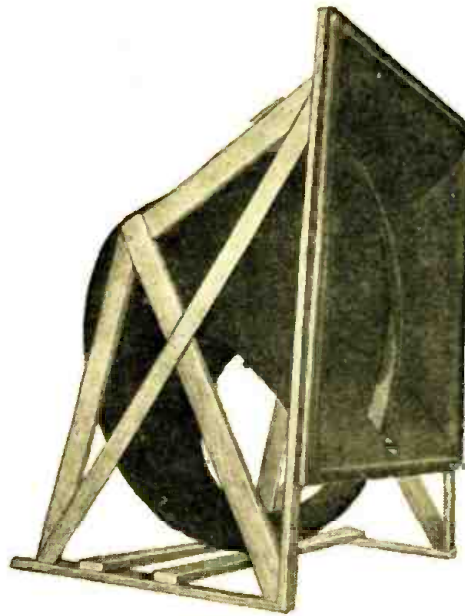

Fig. G

An exponential "air column" ten feet long with a bell 34 inches square. (Unit and horn photos courtesy Racon Electric Co.)

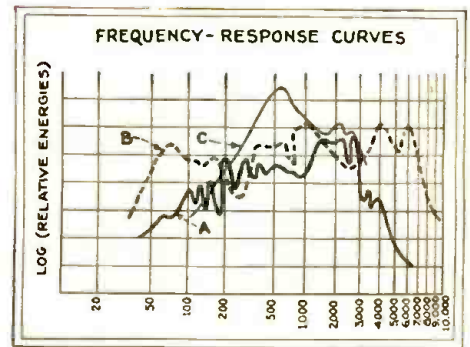

Fig. 2

The characteristic curves of three reproducers: A, dynamic; B, modern experimental type; C, old-style horn speaker.

just what is meant by "broad coverage of the frequency band," and how the various devices of this nature are calibrated.

The Future of Exponential Types

And now to get back to the trend of thought we started on: actual loud-speaker developments. There is one more type which is bound to come in for great use, especially for public-address systems and the like; and this is true because it has great power and great projecting ability.

A great deal of research is being done on the exponential horn, and future possibilities make us look to this type with increasing favor.

Introduction of the talking-motion picture has resulted in the general improvement of this general type of reproducer. Acoustical problems encountered in theaters have indirectly resulted in designs which are capable of filling an average auditorium with sound and voice.

Perhaps the most commonly used speaker for this purpose is the long-air-column exponential horn, powered with a giant dynamic reproducing unit. These sound pro-

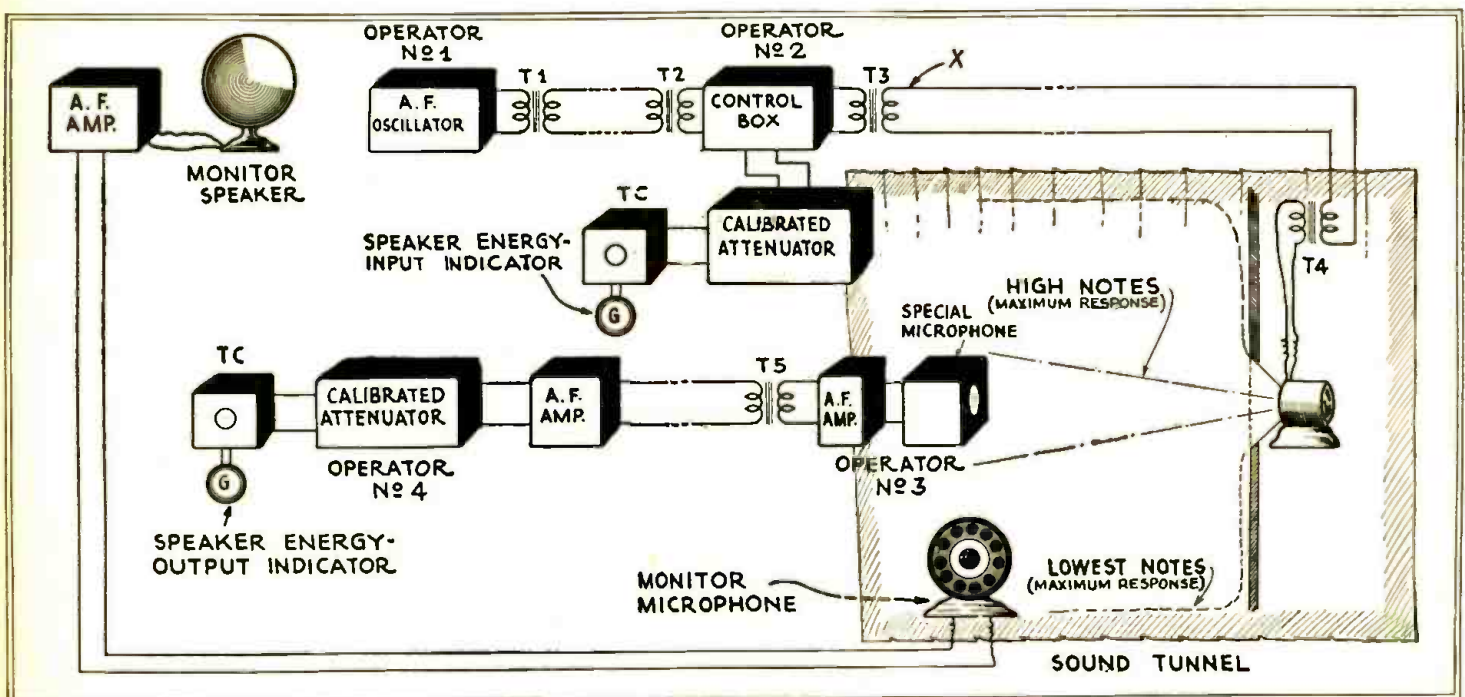

Fig. 3

Arrangement of the elaborate laboratory apparatus previously pictured—the sound room of Fig. B at the right. The microphone, when swung from side to side, responds best to high notes in the center of the room, and low notes at the sides. The set-ups of Figs. C and D are shown schematically at the left and top.



jectors have a ten-foot air column, tapering from a narrow throat to a "bell" with a front opening forty inches square. One of these units, operated in conjunction with a powerful amplifier, is capable of flooding a 5,000-seat auditorium with sound. However, frequently two or more horns are employed in parallel, usually to overcome certain acoustical defects in the construction of the theater, itself.

Construction and design of these speakers is interesting. They are a highly-advanced development of the old horn-type speaker, but built on sound acoustical design. The exponential horn was first made known about four years ago, just about at the time the cone speaker came into prominence. Had not the cone been developed almost simultaneously, it is quite likely that practically all commercial radio receivers would use the exponential reproducer today. The first speakers of this type to make an appearance on the radio market were much smaller than the present theater type, but had the same inherent qualities except that they did not go as low in frequency. They had (and still have) air columns around 100 inches in length, tapering from a narrow throat to a lip a foot and a half to two feet square.

#### How Exponential Horns Are Made

In construction, the exponential horn consists of a long metal throat leading to a sound projector which has non-reverberating qualities and is constructed by a rather unique process. The horn part is made of several layers of canvas impregnated, by hand, with a shellac-and-bakelite compound.

This part of the speaker is constructed by first shaping a metal form, and covering it with canvas. The canvas is then covered with the shellac solution, which is rubbed into every pore of the material by hand. When this layer is completed, another piece

of canvas is stretched over the form, and the saturating process is repeated. After several layers of canvas are laid on in this manner, the horn is allowed to dry. The metal form is then removed, and the horn is again covered with a shellac compound to give the unit a finished appearance. After it is completely dry, the metal throat is attached and sealed to the horn part of the reproducer.

This type of speaker, when completed, is a semi-nondirectional reproducer, casting sound impulses in all directions in front of the lip or outer edge of the horn.

Another new development is a new type of horn speaker with sharply directional qualities, which is capable of hurling a whisper, spoken into a microphone, a distance of three miles. This reproducer was designed primarily for broadcasting from airplanes to large ground audiences, but has found other applications. The horn, shaped like a trumpet, is forty-eight inches long; but, instead of the usual provision for one dynamic unit, it has four throats accommodating four reproducers. Thirty-six inches of the horn is made of the same hardened shellac-canvas material used in the type of speaker described above; the remainder of the unit is heavy cast metal.

With this type of reproducer, sound is projected in a narrow beam; it may be cast in any direction in line with the throat of the horn, and for this reason the new horn may have many future applications in which Service Men can find a successful field of endeavor.

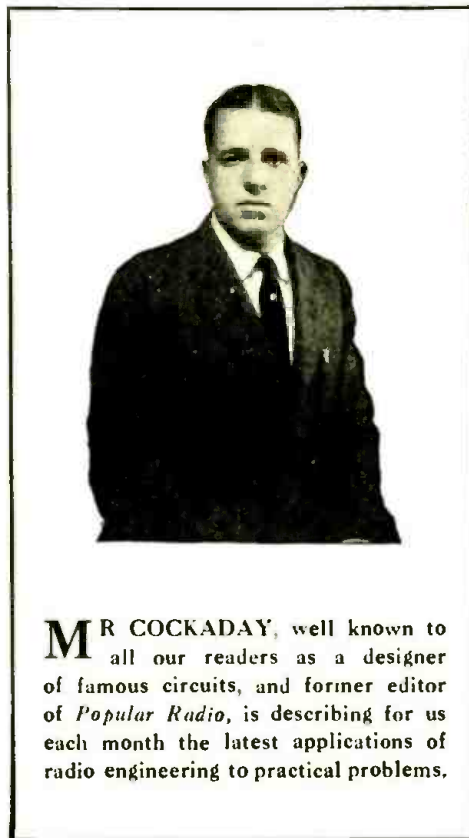

**MR COCKADAY**, well known to all our readers as a designer of famous circuits, and former editor of *Popular Radio*, is describing for us each month the latest applications of radio engineering to practical problems.

## The New Trend of the Radio Industry

By J. E. SMITH

President, National Radio Institute

**T**HE good radio dealer is being sought by the good radio manufacturer. The many evils of the radio industry, such as promiscuous discounts, meaningless list prices, seasonal dumping of goods, profitless servicing and other phases which have heretofore branded radio, despite its standing among the leading industries, as a racket rather than real business, are about to disappear.

There has been and there continues to be an elimination of the poorer kind of radio dealer. It is said that, during the next three months, there will be a further shrinkage in dealer ranks, amounting to perhaps

25 per cent. of the present number. Already the original opportunists, who rushed into radio in the early days, have been eliminated.

The appearance of a powerful group in the radio field marks the dawn of solid radio merchandising. This group is seeking the most competent radio merchandisers in each territory. The appointed merchandisers—a mere handful compared with the usual setup—can handle only the radio line of the new group. The books of the appointed merchandisers are to be checked at regular intervals. The merchandisers must make money, or the group will show them how to make money. Service is to be charged for

at flat rates which insure a substantial profit. Only the best Service Men are to be employed—not the tinkers with whom the radio field has heretofore been plagued. Trade-ins are to be facilitated by a flat bonus granted to the merchandiser for each set. A certain amount is to be allowed on each set for local advertising. There is to be no price slashing, extra discounts, selling to department stores or distress merchandising specialists—no dumping at any time.

Radio merchandising looks more promising than ever before. Good dealers will soon be interested only in sound radio manufacturers.

## Service Problems in Radiola Models

By J. R. DUNCAN

**T**HE following few hints concerning some of the service problems in R.C.A. "Models 44," "46," and "66" may be of interest to other Service Men.

In the "44" and "46" oscillation is sure to occur with considerable annoyance each time that a station is tuned in with considerable volume, unless the metal shields are making perfect contact. They may seem to be making good contact and yet the oscillation will occur. If a condition of this kind

is encountered it is well to remove the shields and polish around the edges with either fine sandpaper or steel wool; and then bend these edges out slightly to make certain that they fit very snugly in place. It is likewise well to polish the spring contacts which connect the shield to the condenser shaft, and to bend them together slightly.

A common service problem with the "66" is a poor contact on the volume control.

This is indicated by the set's becoming very sensitive with a strong tendency to oscillate. If there is a gurgling sound, the rheostat is very likely open. Replace with a new one. In the case of a poor contact, if the Service Man will remove the unit so that the volume control is accessible, the trouble can usually be remedied by bending up the spring at the base of the contact finger; as this will cause the finger to press tighter against the resistance.



# Solving Television's Problems

*A proposal of the application of a well-known optical principle to the purpose of brightening the reproduced image.*

By CLYDE J. FITCH

THE progress of television seems to be taking place step by step; each step in advance giving us new courage, new hope, and a deeper insight into the intricacies involved. While some say that practical television is a thing of the future, and that present methods, even though working 100% perfect, would still be entirely too crude and lacking in detail to be considered worthy of the name, yet all must admit that only by improving present methods can we arrive at future perfection.

In this, the first of a projected series of articles, I will point out one problem in present television methods, and show, or attempt to show, how it may be solved. This discussion deals with the receiving end and the intensity of the illumination of the reconstructed image, which we all know, at present, is considerably below par.

Imagine, for the sake of illumination, a 48-hole scanning disc spinning in front of a neon lamp at the receiver, and let us see what happens. In the first place, we see, at any given instant, only the amount of light that passes through *one hole*. Therefore, if the picture is square, for every unit of light that passes through the hole, 2303 equal units hit the back of the scanning disc! What an enormous waste of precious energy for people who call themselves conservative electrical engineers! The old street lighters put up a better showing than this. Of course, the new Jenkins drum-type radiovisor is a considerable improvement in this direction (as those who read the February issue of RADIO-CRAFT know) but we are at present interested in the more simple, yet inefficient, disc type.

To solve this problem of increasing the lighting efficiency of the disc type radiovisor, I turned to optical principles employed in photometry; the photometer, according to my reasoning, serves the same purpose optically that the Wheatstone bridge serves electrically. To illustrate more clearly, I will first describe the basic principles of the photometer.

## The Photometer

A simple form of photometer, used for comparing the intensity of two light sources, is illustrated in Fig. 1, and consists of a "Bunsen screen" S mounted on a carriage between the two lights being compared, with its surface at right angles to a line passing

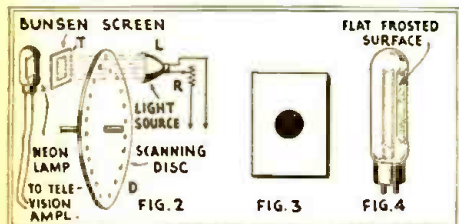

In Fig. 2, the arrangement of Mr. Fitch's proposed television in which stronger light may be used than at present; the expected effect is shown at Fig. 3. A tube like that in Fig. 4 will simplify matters.

through the light sources. It is usually arranged with prisms or mirrors, (these being omitted from the illustration for the sake of clearness), so that both sides of the screen may be viewed at once. The "Bunsen screen" is simply a piece of paper with a circular part of the center made translucent by treatment with paraffin. If the light falling on one side of the screen is stronger, the translucent spot will appear *dark* from that side of the screen, and *light* from the opposite side. When the light falling on the two sides of the screen is equal, the translucent spot disappears. The values of the two light sources are then directly proportional to the squares of their respective distances from the screen.

As an example, suppose the candle C (Fig. 1) is a "standard candle" of one "candle-power," and L is the lamp being compared. If the distance from C to L is 15 inches and the translucent spot disappears when the screen S is placed 3 inches from C, we then



The Bunsen photometer is familiar in every physical laboratory; it operates by balancing the respective intensities of light falling from either side on a translucent spot S.

have the simple proportion  $x : 1 = 144 : 9 = 16 : 1$ ; which shows that the lamp is of 16 candle-power.

The above rule is known as the Law of Inverse Squares, and holds true only when the dimensions of the light sources are small in comparison with the distance between them, and when there are no reflecting surfaces present, as when readings are taken in a dark room.

It is interesting to note here that this principle of the Bunsen screen is largely employed in stage settings to produce "disappearing" optical effects. We have all probably witnessed stage effects in which groups of actors or scenes slowly appear and disappear by a gradual manipulation of the stage lighting. This is done by the use of a translucent screen which divides the back portion of the stage from the front. When the light behind the screen is stronger, everything behind the screen can be seen by the audience; when the light in front is stronger everything behind disappears.

## The "Bunsen Screen" in Television

The manner in which I propose the use of the Bunsen screen in television is illustrated in Fig. 2, which shows the principle diagrammatically only. Instead of "scanning" the light from the neon lamp, as done now with such excessive waste, I scan the light from a powerful light source, L, which should be some 2500 times as powerful as that of the neon lamp. In other words, the light from L,

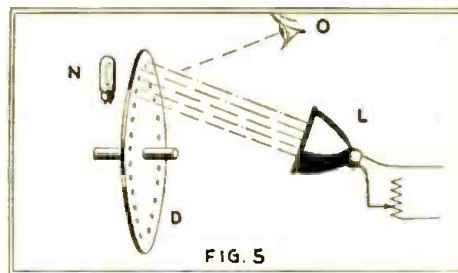

A further extension of the same principle, in which a transparent disc D with black spots would scan the image.

which passes through one scanning hole, in the disc, should have about the same intensity as that of the entire neon lamp. The Bunsen screen T is placed between the neon lamp and the disc, as shown, and is so adjusted that its translucent portion (which should be equal in size to the image being reproduced) disappears when the neon lamp is lit to its average intensity. Therefore, when the neon lamp glows brighter, the translucent spot shows bright on the side of the screen facing the disc and, when the neon lamp becomes dimmer, the spot appears darker on that side.

Suppose we are receiving a simple silhouette figure (such as the black disc shown in Fig. 3). It is evident that the neon lamp apparently goes out every time that a scanning hole in the disc allows light from L to pass through and strike the screen on that portion outlined by the silhouette. Thus, only the area of the screen marked off by the silhouette will have much greater light intensity on the side facing the disc; and only that area will appear dark. The contrast between the dark silhouette and the light background in this case will be greater. It may be enhanced by experimenting with screens of different material and lights of different colors. In the old method of scanning with a 48-hole disc the contrast is equal only to the difference between light of zero intensity and the light that comes through one hole of the disc, or about 1/2304 of the total intensity of the neon light.

It appears, therefore, that the contrast and the amount of light available are much greater, whether we are reproducing silhouette or halftone images. The light source L should be very powerful and its rays should be projected in a parallel path; its intensity should be variable by means of a resistor R. The screen should be placed as near to the disc as possible, and mirrors suitably arranged for viewing the image. The closer the neon lamp also is to the screen, the less light is wasted. The whole apparatus should be housed in a light-proof enclosure, for best results.

One method of obtaining greater efficiency is shown in Fig. 4. Here the neon lamp has one flattened side, which is frosted to serve as the screen, to which the luminous electrode of the lamp may be placed very close with



little loss of light. The pink-orange coloring of the neon lamp is more or less compensated for by balancing it against the white light, (L, Fig. 2). Balancing the light values on either side of the screen is like balancing the electrical currents of a Wheatstone bridge; the slightest un-balancing is easily detected and, since this un-balancing is produced solely by the moving image it appears only on the portions of the screen occupied by the moving image.

#### Alternative Method

Now, for a simpler method, I suggest a radical departure from all known scanning devices—the use of a *transparent* scanning disc with opaque spots, to replace the customary opaque disc with transparent spots, or holes. This disc, rotating in synchronism with the scanning disc at the transmitter, serves the purpose of the Bunsen screen, and is placed between the neon lamp (N, Fig. 5) and a light source L. When the light from N balances that from L, the disc

disappears from view from the observer O. Any unbalancing of the light values, such as would be caused by dark portions of the image which weaken the intensity of the neon lamp N, would cause that portion of the picture, where the unbalancing occurs, to appear dark to the observer; and vice versa. Of course in this case also the apparatus should be inclosed in a light-proof housing with a viewing window for the observer. The disc may be of glass.

To explain more fully, when the light from L which is reflected by the opaque spots to the observer is of the same intensity as the light from N which is transmitted through the disc, the opaque spots disappear. Where light from N does not balance the reflected light (as where a dark portion of an image disappears) the opaque spots become visible to the observer; but only on the unbalanced portions of the picture where the image appears. For example, if the neon lamp flickered continuously at a certain fixed frequency, the observer would see a checker-board formed by the opaque spots, the

opaque spots appearing stationary. If the disc is viewed from the side adjacent to the neon lamp, the lamp L may be dispensed with, but this is mentioned as a matter of interest only, as the observer would only see the amount of light reflected from the neon lamp by one dark spot at a time, and the results would be similar to those obtained with present opaque scanning discs. This does not apply when using the scheme of Fig. 5, in which the lamp L is used. This lamp should be very powerful, similar to that of Fig. 2, so that the light reflected from one opaque spot is equivalent to the total light from the neon lamp. The rest of the light passes through the glass disc and is lost, or absorbed by the black walls of the housing.

These methods of radiovising will probably enable the image to be enlarged to a much larger size than has been heretofore possible; as the amount of light available is much greater. At least they offer a field of experimenting for the television enthusiast which may lead to valuable improvements.

## New Radio Devices for Shop and Home

In this department are reviewed commercial products of most recent interest. Manufacturers are requested to submit descriptions of forthcoming developments.

#### A VERSATILE TIME SWITCH

USERS of the "X-L. Sentinel," a time switch made by X-L Radio Laboratories, Chicago, Ill., are finding the device

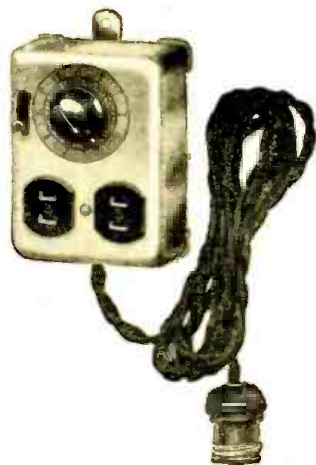

The radio owner who wishes to have his set lull him to sleep may set this switch to turn it off after any given period. Its other applications, also, are manifold.

readily adaptable to turning off or on such equipment as nightlights, small window displays, small signs, and remote-room lights, in addition to controlling the radio.

A spring operates the mechanism which, after it is wound up will throw its switch to the "off" position, within the time limit of the spring motor, which is about five hours.

The aluminum case housing the instrument, measures 3¼-in. by 4½-in. by 2½ in. thick, over all. The knob on the front of the unit is turned to the figure which corresponds to the number of hours over which the unit is to operate. Two light receptacles, wired in parallel, permit connecting both a lamp and the radio receiver or other device to the light-line, and turning off both at the

same time. A knob at the left affords an independent "on" control of the device.

Electrical devices requiring not more than 5 amperes, at 110 volts, may be controlled by the "Sentinel."

#### JEWELL "PATTERN 41" OHMMETER

A TEST instrument, of such precise, yet sturdy construction as to be particularly suitable as shop equipment, designed for making accurate measurement on values of various resistors in power packs, has been introduced by the Jewell Electrical Instrument Co. It is the direct-current resistance measuring device illustrated here as the "Pattern 41" ohmmeter.

The case encloses a 4½-volt battery, which will last several months, for the current con-



This ohmmeter is a convenient device for any workshop; it is a device of laboratory precision, and immediate direct readings up to 10,000 ohms may be taken.

sumption is very low (at 5,000 ohms on the scale, the current drawn is only 15 ma.)

A knurled knob, shown projecting from the base of the instrument, provides adjustment through a "magnetic shunt" to compensate for battery variations. To insure accuracy, the binding posts of the meter are short-circuited before using; the test button is pressed; and the pointer is adjusted to the top of the scale, over a red line. This corrects the instrument for the exact battery

voltage available; and the ohmage of any resistance placed across the binding posts is then accurately indicated in a direct reading on the scale. This convenient correction for battery potential is not only a valuable time saver, but also a great help in maintaining accuracy.

The instrument pictured has a range up to 10,000 ohms.

#### A SERVICE MAN'S KNIFE

MOST Service Men carry a knife of one sort or another; some of these cutting tools are well adapted to the rigorous demands of service work, while others are quite unsuitable. For those afflicted with the latter implements, the knife illustrated here has been developed.

This knife has been standard equipment in the electrical and radio tool kits used in the Government services for the last 25 years; and ex- (military) Service Men will probably recall it as part of their wartime equipment.

The sturdy screwdriver blade is notched and may be used for scraping insulation off wires. Also, it locks rigidly when opened; it is necessary to press the (closed) knife

(Continued on page 661)



This pocket tool is one which will find continual employment in service work; it is stoutly built to stand the strain and knocks of rough work.



# Simplified Automotive Radio Installation

*New design of special receivers for motor cars offer Service Men a money-making opportunity of great value this season*

By SAMUEL EGERT

*Consulting Engineer, Continental Wireless Supply Corp.*

SO much publicity has recently been devoted to automotive radio, that there is today an excellent opportunity for the Service Man to capitalize it by installing and servicing receivers in cars. The advantages are manifold, since every car owner can derive a great deal of enjoyment from radio equipment.

Examination of the trend in automotive receiver design will soon convince the Service Man that he can profitably devote his energy toward this work. To install a suitably-designed receiver in a car is not a difficult job. It will require a little patience during the first installation but thereafter, as experience is obtained, he will find the work simpler and simpler after each success.

The receiver illustrated in the accompanying photographs and diagram was

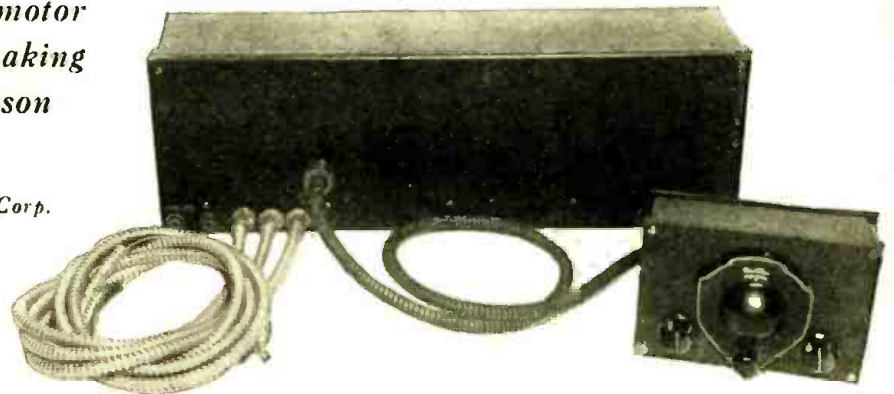

Fig. B

*"The Voice of the Road" receiver, in its cabinet, with control-box at the right.*

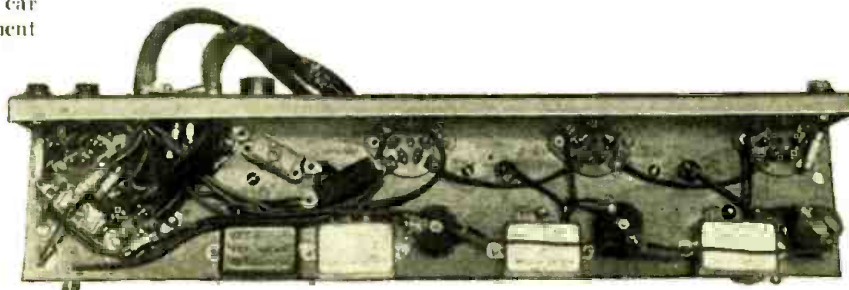
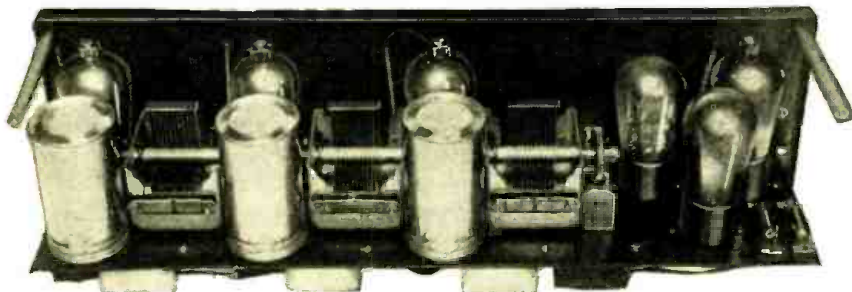

Fig. D

*The under view of the receiver chassis described in this article, showing the complete wiring system. One shielded cable leads to the battery supply, another to the volume control and pilot-light-switch.*

Fig. C

*At right, the chassis slipped out of its cabinet, showing the simple straight-line layout. Note the worm-gear at the right of the condenser gang.*



24 first audio (V5) and a '12 output stage (V6). Its tubes derive their filament supply, as in all automotive installations,

designed especially for the purpose of providing a sensitive, simply-operated set which can be conveniently installed in any car, in whatever location is found most convenient. Since it is extremely compact, only six inches

high and four inches deep (eighteen inches long) it may be put behind the cowl board, under the front floor board of the car, or the board at the rear. The flexibility of the remote-control tuning device permits operation in any part of the car.

The receiver, as the schematic circuit shows, has three '24 type tuned screen-grid stages (V1, V2, V3), a '27 detector (V4), a

from the storage battery of the car. The volume control (R2) is a resistor across the grid coupler of the first A.F. tube, operated from the "control box" which carries also the tuning knob. The latter is connected through a flexible shaft with a worm-gear on the chassis of the receiver; and this gear operates the condenser shaft, as may be seen from Fig. C. The gear ratio is 30 to 1; this is compensated at the control box to give direct dial readings through a complete revolution of the scale.

Installation of the control box, as shown in Fig. A, is done by means of a clamp which is fitted directly over the steering post of the car. A shielded cable connects it directly with the circuits controlled by the volume control and switch, while the pilot light indicates the operation of the latter. The brackets supplied with the receiver permit the cabinet to be mounted where most convenient; and the chassis slides into place (Fig. 2) and out when desired, simply by the removal from the brackets of a front plate which can be taken off in a minute's time.

The receiver is connected through a shielded flexible cable with the "B" and "C" batteries, which may be mounted under one of the seats, or in an airtight battery box fastened underneath one of the floor boards.

Fig. A

*The tuning control-box (1) is clamped to the car's steering post by the nut (2) of a C-clamp. The flexible shaft (3) is of the standard type used for speedometers, having two oppositely-coiled flexible springs. The assembly is shown in more detail in Fig. E on the opposite page. The arrangement given is only one of many which may be utilized.*





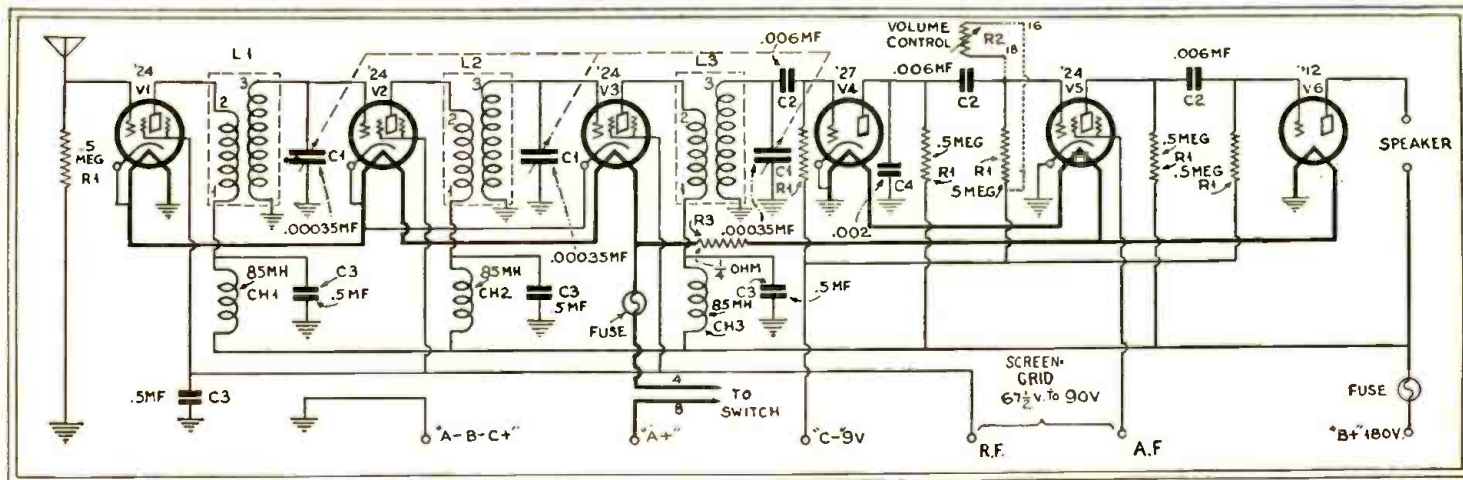

Fig. 1

Latest circuit of "The Voice of the Road" automobile receiver illustrated on the preceding page. The amplification provided is high in both radio and audio channels, giving sensitivity with the small aerial system which can be accommodated in a car. Note the series filament connections and the separate connection for A.F. screen-grid bias.

In an automotive installation, great care should be taken to see that the batteries and their connections are tightly fixed in place; for the car is subject to vibrations and shock. The same care must be taken with the storage "A" battery connections, which are made through a third shielded cable protruding from the front of the receiver.

Before connecting the filament leads on an automotive installation, the Service Man must determine whether the positive or the negative side of the battery is grounded. If the "A—" is grounded, the receiver is connected up as shown. If the "A+" is grounded to the car frame, reverse the battery connections and make the car frame a negative ground, instead. This will change nothing except that it reverses the reading of the charge and discharge meter on the instrument board; the connections to this meter, accordingly, are reversed, and everything will then be in proper shape. The connections to the set are then completed, as shown in the schematic diagram. (Fig. 1.)

The antenna connections may be made by putting a screen-mesh in the top of the car, or by mounting a smaller one (suitably insulated) under each running board of the car and bringing leads to the antenna post of the receiver. It must be borne in mind that the frame of the car itself forms the counterpoise of the antenna; and the aerial must be kept sufficiently separated from this.

The design of the receiver shown here has undergone several refinements. It is fused in both "A" and "B" circuits to prevent blowing out tubes; and, in case of a trouble call, the Service Man should first examine these fuses. If the "A" fuse is blown, he checks his "A" line, and if the "B" fuse is blown, the "B" line is examined.

The plate and screen-grid voltages should be carefully adjusted; some tubes may require a slightly different adjustment for best operation. This should be determined, trying first the "B" voltages shown here. This point is fairly critical, because of the high sensitivity of the receiver, which should be operated just below the point of oscillation.

The circuit values are as follows: C1, .00035-mf.; C2, .006-mf.; C3, 0.5-mf.; C4, .002-mf.; R1, 500,000 ohms; R2, maximum 500,000 ohms; R3, 1/4-ohm. Fuse A is of 5-ampere capacity, and fuse B 1/2-ampere. The R.F. chokes Ch1, Ch2, Ch3 have 85-milli-

henry inductance. The R.F. inductors, L1, L2, L3, are sealed in shield cans of 2 1/4-inch diameter, 3 1/4 inches high. Each coil is

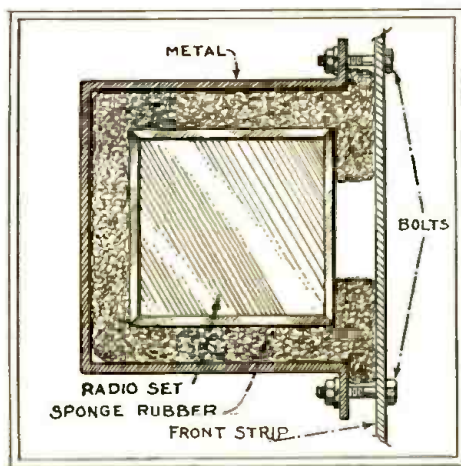

Fig. 2

The shock-insulated mounting of the receiver.

wound on a 1 1/4-inch form, with 116 turns of No. 32 D.S.C. wire on the primary; and the same number, of the same wire, on the secondary. The primary is wound over the secondary, from which it is separated by empire cloth. The winding is 1 3/4 inches long, and the form 2 1/4 inches, mounted in the center of the can.

As shown in Fig. D, the complete wiring layout is under the chassis; the Service Man has only to slide this out of the cabinet, and turn it upside down, to get at every connection. The usual testing methods may be

employed; but the circuit is simple, and should present few difficulties.

The special problem of every automotive radio installation is, of course, the suppression of the noises which are caused by the electrical wiring of the car. The first precaution to be taken into account is to keep the set proper, and all the wiring of the set, as far as possible from any ignition lines of the car. Doing this is half the battle and makes things so much easier in the final test. Noises from the ignition lines are caused by small oscillatory circuits which are formed by the fixed inductances and capacities centered around the spark-plug units. Each ignition lead is nothing less than a miniature sending station, similar to the old spark coil gaps employed in transmitting stations years ago. The work of eliminating this "signal" is accomplished by employing oscillation suppressors in each line; thereby preventing the ignition-coil leads, which go to the distributor and to the coil, from acting as small antennas. The value of each suppressor is approximately 25,000 to 40,000 ohms, according to the make of the car. Resistors are placed directly on each spark coil, and also in the lead from the distributor to the ignition coil. For a six-cylinder car, this requires seven resistors, and for an eight-cylinder car, nine resistors, etc. If, after installing these resistors, the Service Man finds noise still troublesome, the next thing to do is to place shielded wire over the ignition line. Be careful not to place the shield too close to the spark plug, or there may be a sparking-over from the spark plug

(Continued on page 656)

Fig. E

The tuning control-box shown separately; at the left, a standard (18-inch) section of flexible shaft, which may be had in any desired length. The upper coupler fits over a square key attached to the dial gear of the control-box; the similar key on the shaft engages the worm-gear, center; and that the gear (right) fixed on the gang-condenser shaft.

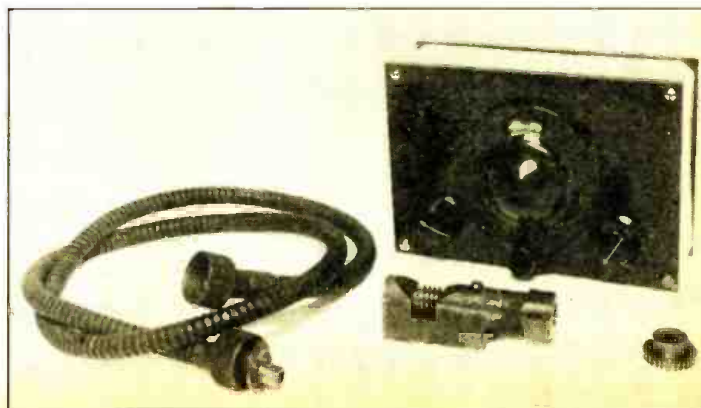



# SHORT WAVE CRAFT

## A Triple-Tuned R. F. Short-Wave Receiver

By S. H. CLAYTON

**T**HE writer has made over forty short-wave sets of different sorts; but none of them compares in its results with that described below. The "Copper-Clad Special" designed by Mr. Robert Hertzberg was a splendid performer; yet I find the receiver shown here, of similar construction but with added tuned screen-grid stages, a great improvement. A number of my friends here have constructed similar sets, and they all work about like mine. I take it that any set which will bring in PHI quite consistently here in sub-tropical Waco, Texas, would perform wonderfully on the Atlantic coast. G5SW is sometimes excellent, but as a rule comes in badly here. W2XAD, W2XAF, W8XK and C.JRX are very consistent here and come in with splendid volume. I can say truthfully that reception from the above stations, on the loud speaker, is as a rule the equal of reception on any broadcast set regardless of make or price.

The apparatus illustrated in the reproduced photographs is the R.F. tuner and detector only, as indicated in the schematic diagram. I used the same circuit in an earlier model about a year ago; but this design is the latest. The length of the cabinet is 28 inches, the depth 10 inches, and the height of the cans  $6\frac{1}{4}$  inches; the three R. F. stage compartments are each six, and the detector can ten, inches wide. My first set was 38 inches long, in three parts.

**T**HE designer of the short-wave receiver shown here is an attorney whose hobby is radio construction and who, like many others, has turned to the short-wave field as offering the best opportunity for such originality as he exhibits here—in the construction of a set with *three tuned screen-grid stages* to work down to thirteen meters, or thereabouts. With the careful placement of parts, roomy shielding, and thorough by-passing shown in the accompanying illustrations, Mr. Clayton finds little trouble in keeping his five-dial set under control, and in bringing in stations with a clarity and volume not available with the many other short-wave sets he has previously built. He tells exactly how it was done, including the layout and coil design; but other constructors may prefer to follow their own ideas, or to use standard commercial material. The resulting short-wave set should be one unequalled, in sensitivity and amplification, except by the costly transoceanic receivers which are used by communication companies, and unavailable to the general public. Those who are willing to undertake the extra cost and effort will be well repaid.

My audio amplifier, with a '12A, transformer coupled, in the first stage, and push-pull '71As in the last, is of the conventional type and placed beside the tuner when in use. I have a jack in the first-stage output, into which I can connect the loud speaker when desired. Across the secondary of the first A.F. transformer, I use a volume-control Clarostat; careful manipulation of which avoids any outrageous tuning noises, grunts, etc. When a station is found, the volume may be turned up with excellent results. The reproducer is an RCA "100A."

I have an outside aerial, 50 feet high and 50 feet long; and on the picture molding an inside aerial, about 18 feet long, which I can use at will. Sometimes, we consider that better reception is obtained from one antenna, and sometimes from the other.

As may be seen, the five vernier dials are the only controls on the front of the cabinet. I see no use in bringing wires to the panel, only to carry them back again; so I placed the rheostats, jack (for detector plate voltage and A.F. amplifier connection), aerial and two small batteries at the rear. An improvised cable supplies the current for the receiver. I use large "Layerbilt" batteries for the detector plate supply; while all other current, both "A" and "B," is furnished from a socket-power Philco unit.

In operation, I first set the detector into oscillation and turn the detector and third R.F. condensers, as nearly in resonance as I can, until a station is located. I then tune these two stages, keeping the regeneration condenser barely at the oscillation point. I tune the third stage exactly; then proceed with the second R.F. condenser, and finally the antenna (first R.F.) tuning condenser until I have them all at their peaks. I find results very gratifying; as I have said, no previous receiver compares with this in sensitivity, selectivity, volume, quality or, I may add, easy tuning. The detector stage is the only one which is extremely critical.

As first built, this receiver used a '00A detector, with negative grid return. On account of the noisiness and the variation in these tubes, I have changed to the '12A as shown.

### Construction

Looking at the receiver, as shown in the view from above, you will see a single large shield divided into four compartments; the top, bottom, ends, sides and partitions are all of 24-oz. copper sheeting, well bolted together to make a solid box. The ends and back are one piece of copper, the flanges adding to the rigidity of the assembly. The

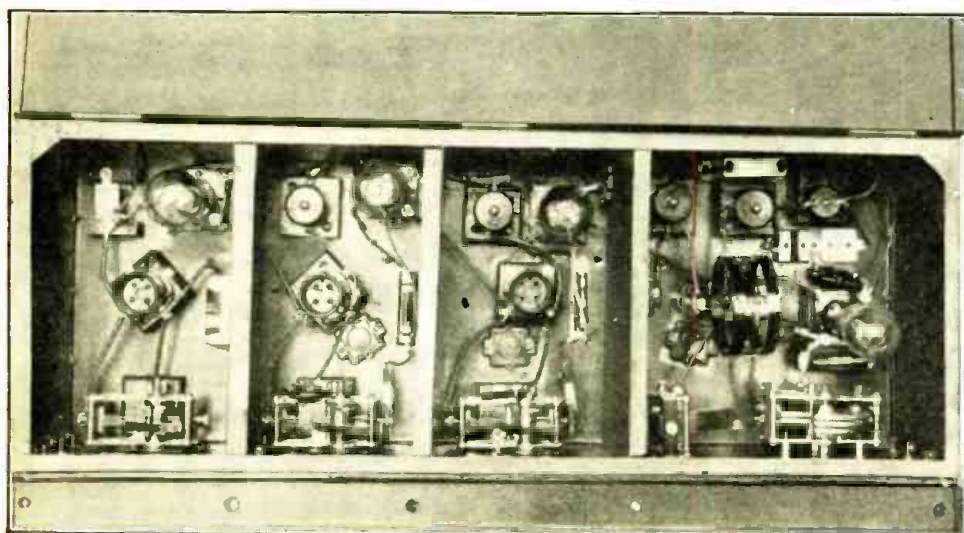

An interior view of Mr. Clayton's completely shielded three-stage short-wave receiver; the copper lining of the cabinet lid forms the top of each shielding compartment when it is lowered. The front shield is separated  $1\frac{1}{4}$  inches from the panel; and the condenser shafts contain insulating couplers, to reduce hand-capacity effects.



lid, which is made of a piece of heavier copper, has a 1/4-inch flange, which fits perfectly, all around, on the copper box. To lessen vibration, the copper lid is screwed securely to the bottom of the cabinet's wooden lid (the last is made out of 1 3/8-inch pine, for weight and steadiness; no vibratory notes have developed so far in my set.) A piece of 3/16-inch three-ply wood is fastened to the copper front, and painted with duco to keep out moisture; five strips, each 1 x 1 1/4 inches, are placed opposite each

At the right, a complete view of the Clayton short-wave receiver; as the rule shows, the cabinet space is 28 inches long. The front panel contains only the four vernier tuning dials and the regeneration dial (second from right) which is also slow-motion. Five hands are not required to operate it, if Mr. Clayton's tuning method is followed. A set of the coils used are on the table in front of the receiver.

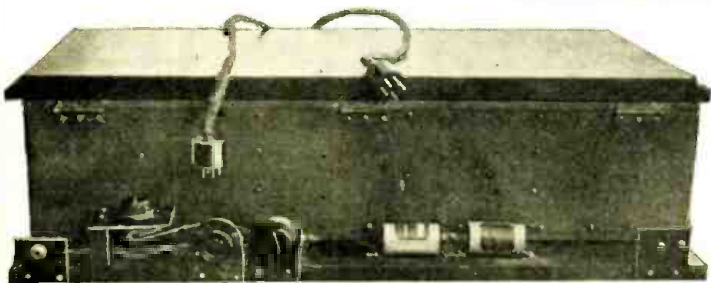
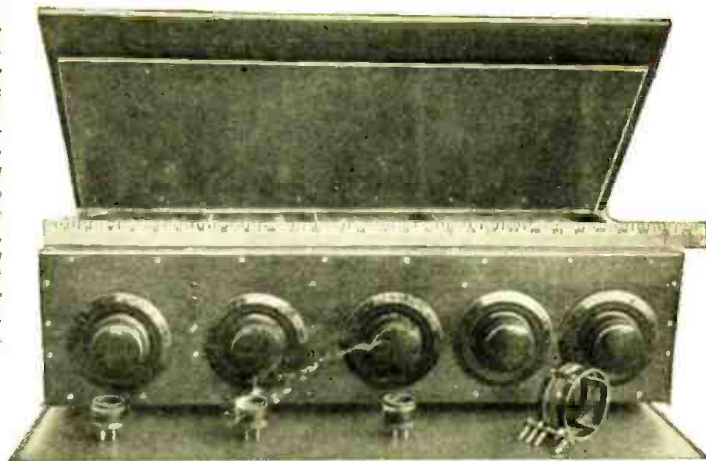

A rear view of the set, showing all connections, the two rheostats, five-contact battery-cable plug and two "C" batteries, outside the shielding.

shield partition to provide for an extension panel of the same three-ply wood, which is placed 1 1/4 inches in front of the first-named wooden panel. The width of this space, which may be seen from the illustrations, is shown by the long 1 1/4-inch strip holding five screws. This extension further removes any possibility of body capacity affecting the three R.F. tuning condensers; two of which, it will be noted, are not grounded. The shafts of these, and the regeneration, condensers were replaced by longer shafts of bakelite; the detector tuning condenser is linked to the dial by a flexible coupling unit. The vernier dials bear close against the outer panel.

All the chokes, the tube sockets, and the tuning condensers at the left are raised an inch from the bottom of the shields by wooden blocks two inches square. Especial care must be exercised with the ungrounded condensers; the openings in the shield for their shafts are made large enough, and paraffin paper is used between these condensers and the shield, as well as between

the copper and the fixed condensers and resistors. So far as possible, the tube-base coils are located in the centers of their shielding compartments; and the same is true of the larger detector coil. The set is adequately by-passed; in addition to the condensers shown in the pictures, one of .01-mf. capacity has been shunted across each '22 tube filament, as diagrammed. Another late improvement has been raising the resistors in the second and third compartments, to make the leads from condensers to control-grid caps short as possible.

**Coil Data**

The dial readings over the bands covered by the respective coils, at high frequencies, are affected by the capacities of the tubes used, as well as by minor details of placement. The waves covered by those which I use are indicated below by the settings for the stations received; there is no accurately calibrated wavemeter available. The first three stages use tube-base coils, as shown in the picture; the detector tuning

coil illustrated is an Aero. I have since wound detector coils on a two-inch form.

I paint my tube-base coils with duco around the bottom, red, yellow, green, orange and maroon; and further mark the stage in which they are to be used. I care very little about anything available over 50 meters; so I have not carried the wavebands above 65 meters.

The coils are wound with No. 22 D. C. C. wire in the first three stages; the shortest-wave detector coils (up to about 20 meters) have No. 14 D. C. C. secondaries, and the two longer-wave coils (yellow and green) are of No. 18 wire. The ticklers are all No. 30 D. S. C., wound unspaced, and separated 1/8-inch from their respective secondaries on the forms. In the maroon and orange (shortest-wave) coils, the turns are spaced 1/16-inch apart; in the others, 1/8-inch. The following are the numbers of turns in my home-made coils, which have been brought to fit the tubes, condensers, etc., which I use:

| Coil Set | Number of Turns |       |        |       |
|----------|-----------------|-------|--------|-------|
|          | L1              | L2    | L3     | L4    |
| Maroon   | 1 3/4           | 1 1/4 | 1 3/4  | 1     |
| Orange   | 3               | 3     | 3 1/8  | 1 1/2 |
| Red      | 4 1/4           | 4 1/4 | 4 3/4  | 3     |
| Yellow   | 7               | 7     | 7 3/4  | 4 1/4 |
| Green    | 9 1/4           | 9 3/4 | 10 1/2 | 5-1/3 |

(Continued on page 658)

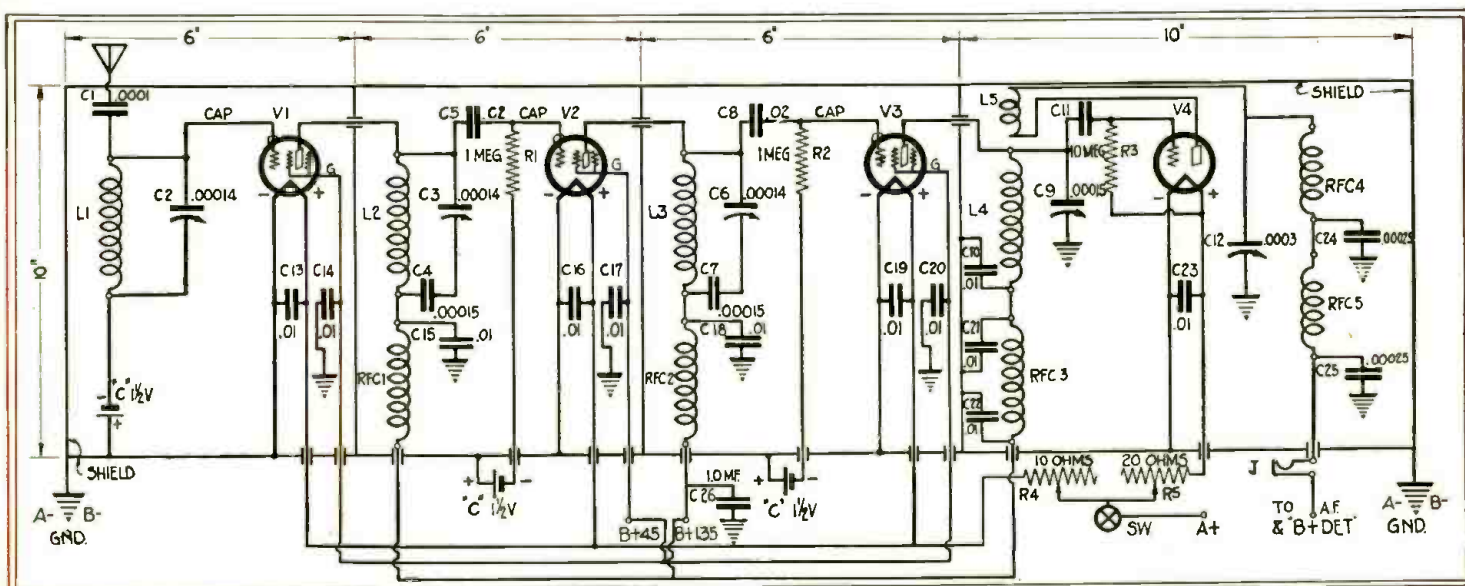

The circuit of the Clayton short-wave receiver, with its three tuned R.F. stages ahead of the standard regenerative detector. Mr. Clayton uses it only to cover the band below 50 meters; but there is no reason why its range should not be extended as far upwards as the constructor cares to provide coils for. It would appear that the coils must be matched, each to its condenser, if the dials are to come anywhere near tracking.



# How to Tune for Foreign Short-Wave Stations

*Some Practical Hints for the Distance Fan in a New Field*

By **ARTHUR J. GREEN**  
President, International Short-Wave Club

**W**HEN the broadcast listener starts experimenting in short-wave broadcast reception, he finds many conditions to which he has not been accustomed; such as the sharpness of tuning with the most distant stations, the ever-changing reception conditions, and the broad spaces on his dials where he is at a loss to know what wave he may be tuned to. These three things have been the cause of many

experimenters throwing up their hands in disgust and swearing that overseas broadcast reception is "just so much bunk." It is only after the operator has obtained a knowledge of short-wave tuning that he succeeds to any extent in getting good results; and this knowledge cannot be gained in a moment.

On the standard broadcast set of to-day, we have the wavelengths in meters or the

kilocycles marked on our dials; we have also station lists showing exactly what wave each station operates on; and reception is simply a matter of turning the dials to the corresponding figures. Even if the wavelengths are not marked on our dials, there are many powerful stations of known wavelength which establish points of reference to guide us to the stations wanted.

But this is not true in short-wave reception. Most short-wave sets are marketed in kit form, and must be put together, either by the experimenter or by some Service Man whom the owner gets to do it for him. Each constructor makes slight differences, in the layout of parts or in the choice of accessories, antenna, and so forth. At the high frequencies associated with short-wave broadcasting, a receiver is very sensitive to the slightest changes; and therefore no short-wave set can be calibrated in advance like the medium-wave broadcast receivers. The manufacturer can give, only approximately, the waveband which each coil may be expected to cover, and lets it go at that. To give the newcomer in short waves a coil that will cover, say, three hundred channels as wide as those used in ordinary broadcasting, and ask him to find a station on the dial is a good deal like asking him to find a needle in a haystack. However, with a little patience, and the use of simple division, a set may be readily calibrated after it is once set up and working.

### Harmonics and Calibration

The short-wave beginner is usually surprised to begin picking up broadcast stations which he cannot find in the short-wave list. What he hears is the *harmonics* of stations broadcasting on the medium waves between 200 and 550 meters. These are often a nuisance, for they may be poorly modulated, and they are easily mistaken for a foreign station—and sometimes they interfere with wanted foreign stations. The last-named trouble is one which will have to be dealt with, as short-wave broadcasting becomes more general; but at the present time the experimenter will find these harmonics useful for the calibration of his dials.

Each harmonic has a definite wave, just as much so as the broadcast station's fundamental carrier wave. A harmonic must have exactly twice, three times, five times, nine times, etc., the frequency of the fundamental (corresponding, respectively to 1/2, 1/3, 1/5, 1/9, and so on, of the fundamental wavelength). Many of these harmonics can be heard with any short-wave receiver. When one of them is picked up, and the station identified, it is only a matter of division to determine the exact wave to which the receiver is tuned. By checking up a number of these harmonics, and the few known short-wave broadcasters, it is a very simple matter to draw up a calibration curve for each coil of any short-wave set.

### COIL No. TWO Range 30 to 55 Meters (Approximately)

| Dial Reading | Wave-length | Stations Heard  |
|--------------|-------------|---|
| 0            |             |   |
| 1            |             |   |
| 2            | 30.01       | WRVA (9th Harmonic—fundamental 270.1 meters)                  |
| 3            | 30.50       | NRH, Heredia, Costa Rica, 10-11 p. m. daily                   |
| 4            | 30.85       | WBT (9th Harmonic—fundamental 277.6 meters)                   |
| — 5          |             |   |
| 6            | 31.04       | KQV (7th Harmonic) 7LO, Nairobi 11-2 p. m. daily              |
| 7            | 31.26       | W3XAU — PCJ — VPD — K1XR                                      |
| 8            | 31.38       | .....Königswusterhausen (Berlin) Germany                      |
| 9            | 31.48       | W2XAF — OXY, Lyngby, Denmark, 2-3 p. m.                       |
| —10          | 31.80       | XDA, Mexico City, Mexico                                      |
| 11           |             |   |
| 12           | 32.10       | CGA, Drummondville, Canada                                    |
| 13           | 32.20       | WSAI (7th Harmonic—fundamental 225.4 meters)                  |
| 14           | 32.40       | GBK, Rugby, England (transatlantic phone)                     |
| —15          |             |   |
| 16           | 33.26       | GBS, Rugby, England (transatlantic phone)                     |
| 17           |             |   |
| 18           | 34.23       | KSTP (6th Harmonic—fundamental 205.4 meters)                  |
| 19           |             |   |
| —20          | 34.68       | W2XAC, HKCJ   |
| 21           |             |   |
| 22           |             |   |
| 23           |             |   |
| 24           |             |   |
| —25          |             |   |
| 26           | 40.00       | WWRL (5th Harmonic—fundamental 199.9 meters)                  |
| 27           |             |   |
| 28           | 41.80       | KSTP (5th Harmonic—fundamental 205.4 meters)                  |
| 29           |             |   |
| —30          |             | AMATEUR PHONE BAND  |
| 31           |             |   |
| 32           |             | VRY, Georgetown, British Guiana (Wed. and Sun., 7:15-9 p. m.) |
| 33           |             | Code (Mobile services)  |
| 34           |             |   |
| —35          | 46.12       | WHAP (5th Harmonic—fundamental 230.6 meters)                  |
| 36           |             |   |
| 37           | 46.92       | WOR (9th Harmonic—fundamental 422.3 meters)                   |
| 38           |             |   |
| 39           |             |   |
| —40          | 47.59       | WLBL (7th Harmonic—fundamental 333.1 meters)                  |
| 41           |             |   |
| 42           |             |   |
| 43           | 48.35       | HKT, Bogota, Columbia, 10-11:30 p. m.                         |
| 44           |             |   |
| —45          |             |   |
| 46           | 49.02       | W2XE, New York  |
| 47           | 49.40       | W8XAL, Cincinnati   |
| 48           |             |   |
| 49           | 49.80       | W9XF  |
| —50          | 49.98       | HRB, Honduras, Mon., Wed., Fri., 9-12 p. m.                   |

Half a sheet of a short-wave log, showing where stations are heard or expected.



Take a sheet of paper for each coil, and number each from top to bottom with figures corresponding to those on the tuning dial or dials, usually 0 to 100. (These numbers do not correspond to the settings of the regeneration dial.) Start with any one (or pair) of the coils covering a certain waveband; and tune in the first station you come to. If it is a regular short-wave sta-

tion, mark down its known wave exactly opposite the figure on your chart which corresponds to the dial setting. If the station is one which is not known to have a short-wave transmitter, then it is a safe bet that you have heard a harmonic. Look up the authorized wavelength of the station, and divide it by the number which will bring the result nearest to the wavelength to which the coil should be tuned. For instance, if the coil is rated by the manufacturer as covering from 30 to 55 meters, and your condenser setting is low, you are reasonably sure that the wavelength must be somewhere between 30 and 40 meters. If the station heard is working on a fundamental of 274.9 meters (1,080 kilocycles), you will see that dividing this by nine gives 30.54 meters (9,720 kilocycles) and this is the wavelength of the ninth harmonic, which you are presumably hearing. (The odd harmonics are usually of much greater strength than the even harmonics.—Editor.)

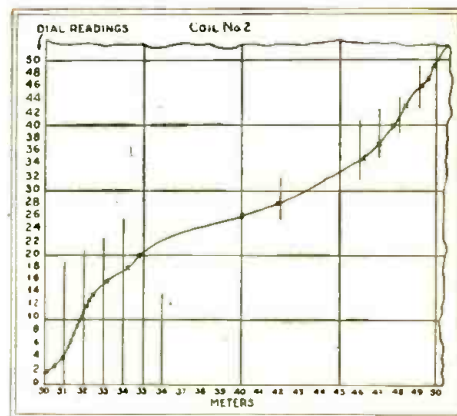

Fig. 1  
The notes of the log sheet opposite, transferred to a calibration chart for the coil.

brated the dial from top to bottom on our chart (see Fig. 1); and so with each of the other coils until we are able to determine where any given wave may be tuned-in on our receiver; then we are enabled to search for stations right where they may be expected.

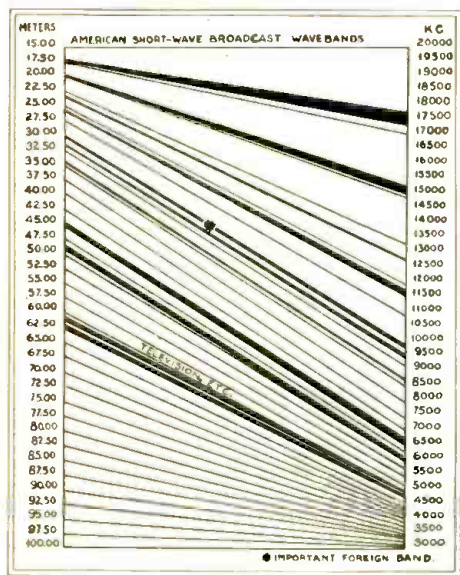

Fig. 2  
The bold black bands show the short-wave broadcast channels. Note how they crowd at the lower end of the meter scale.

Mark the wavelength found—30.54—on the proper sheet opposite the condenser dial reading. It is necessary to carry the wavelength out to two places; for a tenth of a meter covers considerable room on a short-wave dial.

Suppose we go up slightly on the dial, and find a harmonic of a broadcast station which is known to be working on 215.7 meters (1,390 kc.). Since the seventh harmonic of this station is 30.81 meters (9,730 kc.) we set down this figure opposite the second dial reading. In this manner we progress until, so far as we are able, we have cali-

**Tuning Problems**

Our task is not ended, however, even when we have the receiver well calibrated. We must consider the great sharpness of tuning on short waves; compare it with the broadcast band. In the United States and Canada, exactly 96 broadcast channels are in use—

(Continued on page 659)

## Short-Wave Operation from a "B" Unit

By L. H. HOUCK

THE method of adapting a "B" power unit to short-wave receiver operation, shown here, is not offered as a panacea; but the short-wave listener who follows it carefully will find better reception than he can obtain with batteries, and most sets will be more easily handled.

This unit was especially designed for a battery-model "Super-Wasp," which did not take kindly to "B" unit operation. (This comment has no reference to the later A.C. "Super-Wasp" model, which has since become available. However, many people will prefer the first model, because of its incorporation of the 71A tube. While the special '27 tube used in the A.C. model gives quiet operation, in most cases it is found that the volume is considerably lowered.) The "Super-Wasp" was operated for a period of about two months with battery equipment, exactly as specified, and a careful chart kept of the results. Then, after several "B" units had been tried on it without spectacular results, it was decided to assemble one from spare parts and keep on making changes until a way was found to give results that would equal or better battery operation. This was done; though some credit must be allowed for the fact that we have become more familiar with the operation and characteristics of the set.

As shown by the diagram, a standard hook-up was used, with an extra choke coil L in the positive lead, and an extra 4-mf. condenser C. However, it was found to

work as well with the condenser bank left at 14 mf., but divided between the chokes, with at least 8 mf. across the output. Variable resistors (Clarostats) were placed in series with all the leads except "B—." With these set as near zero as possible, a good short-wave station was tuned in (we used KDKA, as we are located on the Pacific coast) and, when it was at about normal volume, the resistors were all adjusted, without reference to voltage readings, for the effect on the signal quality and strength. It was found that for each resistor there is a certain setting which gives remarkable results. A surprise awaits those who carry the experiment to this point before taking voltage readings, as these will not be anywhere near what you expect.

When once adjusted, the settings should be untouched until it is necessary to change a tube, when the plate voltage of that tube must be regulated. The use of the two resistors shown in the "B+45" lead is desirable to permit regulation on the detector and the screen-grid voltages separately.

In working up to the point of adding the third choke, it was found that a pair of matched coils, one on the negative and one on the positive side of the circuit, gave decided hum. This could not be altered by changing the values and connections of the condensers; if the operation was apparently smooth and quiet, it invariably developed a heavy background noise in regeneration. With the circuit shown, operation is as quiet as with batteries, with an extremely low noise level when the regeneration control is turned up to the oscillating point. Several stations which had never been heard on battery operation were brought in with the aid of this supply unit.

While the idea of adjustable plate voltage is not new, it is sometimes necessary to resort to all the tricks in the bag in connection with short-wave reception. Also, while our modern tubes are not supposed to be critical as to plate voltage, if used at their rated capacity, they will operate more efficiently with adjustable voltages from 100 meters down to 20.

Mr. Houck adds an extra section ahead of a standard "B" unit, and finds it very satisfactory to operate a short-wave receiver. An adjustable voltage divider is necessary for best results.

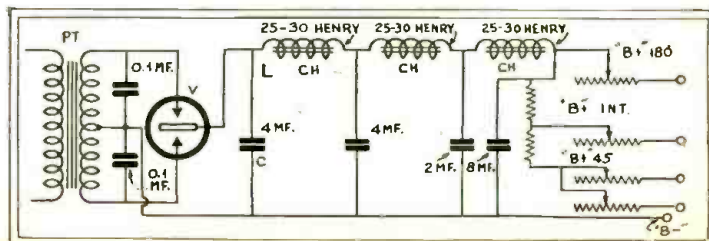



# Correspondence From Short-Wave Fans.

*What Our Readers Are Hearing and Doing*

## SHORT-WAVE STATIONS

Editor, RADIO-CRAFT:

An Italian station, heard several times lately, has given its call as 3RO; it is the new 12-kw. station built for Radio Roma (Rome, Italy) at Cecchignola. Testing waves are 25.4 and 80 meters. It is supposed to be on after 10:30 a.m.

VK2ME verifies reception of GBX on 15.55 meters. These are experimental broadcasts.

I have heard so many strange Spaniards that I have just given up. I hear from the Short-Wave Club members in the West Indies that there are stations at Medilum, Colombia; Barranquilla (two) Colombia; Las Vegas, Dominica; somewhere in Venezuela; Manizales (two) Colombia; Santiago, Chile; Santiago, Cuba; Havana (two) Cuba; San Jose, Costa Rica; and CM6XJ at Tuinucu. The last is authentic, as Mr. Jones, the owner, is a member of the Club. (I have just received a new member from Germany and another from Kingston, Jamaica. Both mention RADIO-CRAFT.)

There is not, and never was a short-wave station at Johannesburg, South Africa. The station officials claim this was started by some fan's picking up a harmonic, and failing to recognize what he had.

A station on about 31.48 meters (WGY's wave) has been heard here many times near 5 p.m. E.S.T. This seems to check up with the Eiffel Tower.

ARTHUR J. GREEN,  
Box 713, Klondyke, Ohio.

(Mr. Green, who is, perhaps, the most successful short-wave broadcast listener in the United States, has written for this issue of RADIO-CRAFT the first of a series of articles on practical short-wave broadcast reception; which will be useful to the beginner and, possibly, even more to the experienced listeners, in getting the most out of their equipment. Other listeners sending in station reports include Emil Husemann, No. Hazleton, Pa.; George C. Starry, Brooklyn, N. Y.; Roy E. Goad, Fillert, W. Va.; Page Taylor, Detroit, Mich.; and Edwin Amlerbach, Quakertown, Pa.—Editor.)

## PARLEZ-VOUS FRANCAIS?

Editor, RADIO-CRAFT:

I have read your magazine since it first came out, and think it one of the finest on the market. I am experimenting with a three-tube regenerative receiver, and have heard about thirty stations, not including code. One of these sounded like a foreigner, but did not speak a word of English from the time we tuned him in until he signed off. Like Mr. Starry, I think it is provoking to listen to a station and not hear him announce.

I wish to commend Mr. Green's short-wave bulletin for the short-wave listener; it is one of the best.

Is it possible to hook up an A.C. screen-grid tube, with D.C. on the filament, as a radio-frequency amplifier on short waves?

E. W. REDMAN,  
400 East Lafayette Ave.,  
Baltimore, Maryland.

(An A.C. screen-grid tube may be hooked up with D.C. on the filament; in fact, this is standard practice with automobile radio receivers, which are operated from an automatically-charged battery. However, the inter-element capacity of the '24 is higher than that of the '22; the merit of the former, on short waves, is that it may be operated from a power transformer. For battery use, the '22 seems preferable.)

Mr. Redman's objection to exclusive foreign-language announcements will be heard sympathetically by many listeners. However, it must be remembered that English-speaking people are, after all, in a minority in the world covered by short-waves; and every station may be expected to use its own language on most occasions. At the time we read this letter, there lay before us the French radio paper *L'Antenne* with an editorial, "English Spoken," expressing the opinion that announcing in English is being overdone and that the French language, because it is "the most wonderfully precise, logical and harmonious in the world," should be used for international broadcasting, as for international conferences. Important European stations give programs in several languages, usually including English, French, German and Spanish as the principal international languages; and the first three, as well as Esperanto, are used in the Orient.—Editor.)

## SHORT WAVES IN KANSAS

Editor, RADIO-CRAFT:

Mr. Raymond McComb wonders if the central part of our state is too far away from Europe for short-wave work. I can assure him that it is not, for I enjoy G5SW on the loud speaker; I get it easily any time. Some of the Hollanders have also been brought in, though I have not as yet received their verifications. The U. S. has been raked from corner to corner with my new receiver (about the fifteenth I have built) and very shortly I am going to drop everything else and see just what this little set will do in a 24-hour test. I shall be very glad to communicate with Mr. McComb, or anyone else interested in short-wave work.

R. S. MOFFETT,  
Box 104, Coyville, Kansas.

I have never seen a report on short-wave reception in this section. I receive the U. S. and Canada in fine shape on detector and one audio; I think it would be possible to get foreigners with a larger receiver. Schenectady comes in exceptionally well with very little swinging, good volume and excellent tone. Perhaps the best feature is the negligible amount of static below 40 meters. I will be glad to enter into correspondence with short-wave experimenters to exchange ideas, and help if need be.

LESTER F. WING,  
Argonia, Kansas.

I have repeatedly heard G5SW, VK2ME, G5GW, GBS and a few other European and Australian phone stations. I have been in the amateur game for several years, and these were picked up while I was working with other stations. I use a two-step Schnell receiver that I built two years ago; and I have yet to be shown a screen-grid set that works better.

H. A. MILLER, W9CDP,  
Cawker City, Kansas.

## DIRECT AERIAL COUPLING

Editor, RADIO-CRAFT:

After adding another stage of audio to the "Craft-Box" (October RADIO-CRAFT) and putting a variable resistor across the first A.F. secondary, I am getting good results on foreign stations. I find that results are much improved without the aerial coupling condenser; just bringing the lead-in to the '22 tube cap. I have been listening to VK2ME and other foreign stations.

NICK GAUG,  
21-36 42nd St., Astoria, N. Y.

(The purpose of the aerial condenser is to bring the constants of the antenna to the best value under varying conditions. If the aerial is exactly the right length and capacity without it, so much the better; but without this adjustment, it will usually cause "dead spots" on the tuning dials.—Editor.)

## SCREEN-GRID DETECTION

Editor, RADIO-CRAFT:

Where are all the short-wave fans? From thousands of them, only a few letters come in. Their contributions would not only pep up the magazine, but they would be most interesting to all readers.

I use a completely-shielded screen-grid set with a tuned R.F. stage and a screen-grid detector of the space-charge autodyne type, with but one stage of resistance-coupled audio. Results have been most gratifying: in two weeks' time I have had 35 stations below 60 meters, including VK2ME. I heard the Byrd program rebroadcast from New Zealand. The regeneration control on this set cannot be beaten; it performs well, too, on the broadcast band. I would like to hear from anyone else who is using a screen-grid short-wave detector.

CHARLES ZELAITES,  
Lincoln, New Hampshire.

(It is the endeavor of this department to carry as many letters from short-wave fans as our space will permit; it is necessary to select those which carry most practical information as to foreign station schedules, or constructional details, rather than the majority which merely tell about hearing well-known stations. The more letters we receive, the wider will be the range of interest from which to select.—Editor.)

## IN DEFENSE OF SKIP-DISTANCE

Editor, RADIO-CRAFT:

I think Mr. Green is very much mistaken when he says "there is no such thing as skip-distance, except for the first few miles." That being the case, I would ask him how long he has been on the short waves? Let him try the 20-meter band any morning and see if there is no skip-distance. For the past twelve years I have been an amateur, and for the past three I have been working on 20 meters consistently; so I have had a chance to study the vagaries of these waves. The only time anything inside of 1,000 miles is heard is in the afternoon. This has proved to be the case wherever I have been, all over Canada from Winnipeg to Newfoundland.

While there is a lot in being able to operate your receiver, no amount of knowledge can bring in a station where skip-distance is effective. I would like to have Mr. Green drop in anytime he is up this way, and I'll show him some real skip-distance.

VALENTINE SHARP, VE3VS,  
336 Sydenham St., Kingston, Ont.

## HOLLAND TO NEBRASKA

I do not think Kansas is too far from Europe for short-wave work; as I have received PLE, Bandoeng, VK2ME, Sydney, KIO, Kahulu, Hawaii, DIV, Nauen, several of the Dutch stations, G5SW, several phone stations in England, France and Argentine, and XDA, Mexico City. I use a Pilot "Super-Wasp" with a special audio amplifier, which I wired myself, using a '50 power tube. Batteries are used on the '22 and detector, and a S-M "Hivolt" unit for the audio end. I have a Utah "Stadium" dynamic speaker, mounted outside my radio service shop; and I have put PHH and G5SW on this speaker so that they could be heard for two blocks (these were their own transmissions, and not relays). I would also like to know if the other short-wave fans miss Amos 'n Andy since KDKA stopped putting them on the short waves; we do out here, because we could get them early in the evening only in this way.

LIONEL W. KINSEY,  
Humboldt, Nebraska.

## CORRESPONDENTS WANTED

I am making a collection of photographs of amateur's short-wave receivers and transmitters, and would like to have all amateurs send in theirs. Any pictures, station, set, or its interior will be appreciated.

JOSEPH BRIGHT,  
826 East 221 Street,  
New York, N. Y.

(Or, what have you?—Editor.)

Why not give the power of the short-wave stations, as the radio logs on long-wave stations do? (It keeps us busy, at present, trying to get the right letters and wavelengths.—Editor.) I would like to correspond with anyone, and will answer any letter.

W. C. GOSCHL,  
296 Peck Street,  
New Haven, Conn.

—I will be glad to help any readers of RADIO-CRAFT.

BEN F. LOCKE,  
Box 117, Route 2, Seneca, Mo.

I have been working with radio for five years, and would like to correspond with any fans of my age (15) or over.

ARNOLD SIMMONS,  
2921 Burrell Place, Detroit, Mich.

(We are waiting for someone under 60 to request correspondence from younger fans.—Editor.)

I would like to communicate with some "ham" who has the plans for a cheap, efficient C. W. transmitter working on '01As, '12s, or '71s; and from someone who has built a "Super-Wasp" adapter to work with an A.C. broadcast set.

BILL FINCH,  
800 Forest Hill Boulevard,  
West Palm Beach, Florida.



# Modern Sound Projection (V)

## A Few Notes on Practical Maintenance Work

*Some advice to the junior projectionist on the practical problems of keeping disc or film equipment in efficient condition*

By LAWRENCE F. HEAPHY, JR.

ONE of the most unpleasant things that can happen in disc reproduction, and one that happens all too frequently, is the sound going out of synchronism with the picture. An alert projectionist, however, may do much to correct this fault, or at least help it, if he is willing to spend his time outside of show time to gain the necessary skill and experience. Perhaps the first thing to look at is the turntable and reproducer.

Start your motor and bring it up to normal speed, and rest your hand at some convenient place on the turntable base in order to determine the amount of vibration present, then take the pick-up in your hand and note the vibration there. Of course, you will readily realize that vibration in either the turntable or pickup is far from being desirable. If you feel that these parts are undergoing undue vibration, try to determine the source of this vibration; which may be in the couplings, universal joints, worn gears, improper alignment between projector and turntable, etc. Determine the cause of any vibration and, if possible, remedy it. If you are getting occasional vibration from extraneous sources (such as walking in the booth, slamming doors, street cars passing, trucks, etc.) it might help to insert a piece of block cork or heavy tough rubber under the legs of the turntable as well as the projector. Be careful not to use too much, and to see that it is placed so that the legs will not "creep."

Now determine that the turntable is absolutely level, by placing a spirit level on it in all directions. If the table slants in any direction level it by means of the screws, clamps, or whatever adjustment your particular equipment embodies. When your turntable is thus aligned, see that the reproducer or pickup is in line; that is to say, when the needle is placed in the needle receptacle all the way, no part of the record can possibly come in contact with any part of the pick-up.

See that the pick-up arm "rides" correctly. To ascertain this, take a record which is smooth on one side and place it on the turntable, smooth side up; put a new needle in the pick-up and start your turntable, bringing it up to normal running speed. Place the needle at the point nearest to the center of the record. It should ride naturally to a position, about two-thirds of the way to the outside of the record, where it should remain, no matter how long you let it run. Now place the needle (with the turntable still running) as near the outermost part of the record as possible; and it should naturally ride to the same position as before, two-thirds of the way across to the outside.

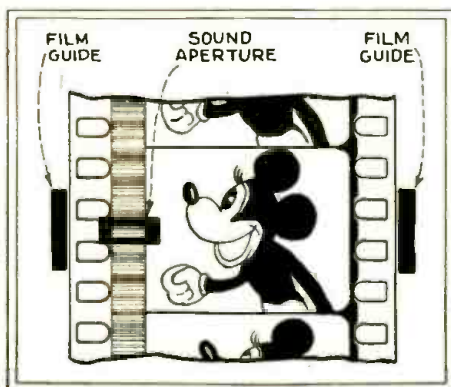

Fig. 1

*The entire quality of reproduction from film depends upon the exact alignment of the sound aperture over the sound track on the film.*

If the pick-up does not perform in this manner, either the bearing on the pick-up arm does not permit free motion, the pick-up arm is not weighted or counterweighted properly, or the arm support is not level. You may easily determine this by experimenting until you get the desired result of the pick-up riding to the position approxi-

mately two-thirds of the way across the smooth surface of the record to the outside.

With your turntables and pick-ups thus in alignment and free from vibration you have eliminated a great deal of the source of trouble experienced with "going out of sync," so far as you and your machines are concerned. A careful check at regular intervals, to see that your machines stay this way, is also a wise plan to adopt.

### Problems of the Needle

You will find that a record will sometimes "single-track" or jump a groove, in spite of all your efforts to prevent it. It is, of course, presumed that you always check the needle you are inserting, to see that it is absolutely perfect; also that you replace the needle after each and every record. Too much stress cannot be laid on this point; for the would-be "economy" of repeating on needles will show up at the box office with loss of business due to the sacrifice in quality, not to mention the damage done to the records by this practice. You will find when a record jumps with a full-tone needle, that if, the next time and thereafter, you use a half-tone or a low-

*(Continued on page 661)*

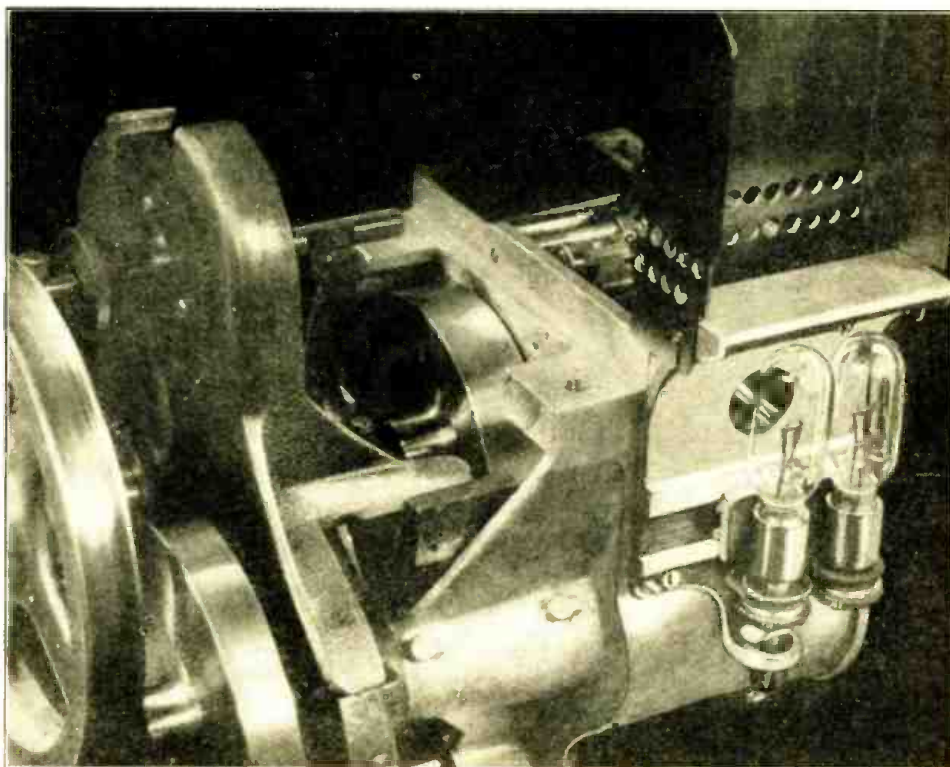

Fig. A

*The sound-on-film head, with the exciter lamp opposite the lens assembly leading to the cell "window." It is adjusted by the knurled wheel. Note the spare lamp at the extreme right, ready to replace the other instantly if needed. (Courtesy: De Forest Phonofilm.)*



# The Cooperative Radio Laboratory

*Some reminiscences of old-time radio experimenting, and a discussion of the effects of varying types of detection on the Loftin-White direct-coupled audio amplifier*

By DAVID GRIMES

**A**FTER writing this Cooperative Laboratory department for a strenuous period of several months, we have been considerably encouraged by the receipt of many letters offering really constructive suggestions. To some of you, it undoubtedly looked like a one-sided affair, as the continued suggestions month after month have always been made by us. But it requires a long time for things to take hold, even in Radioland. President Eliot of Harvard used to say that "the first hundred years are the hardest" when instituting a new procedure.

Honorable mention for the best experimental suggestion received this month goes to R. P. Lowther, of 162nd St., New York City, who says, in part: "As a constant reader of your magazine and a follower of the Co-Op. Lab, I want to tell you a word about my experiments with the Hybrid-Crystal set. I built one that is satisfactory in every way, and have no trouble with the sensitive end of the crystal, because I grounded it with a .002-mf. condenser. The reason for this is simple—not all the R.F. wave is rectified, and what is not rectified is by-passed. No shielding required."

Mr. Lowther then goes on to mention the use of a high-amplification A.C. tube in place of the standard low-"mm" '27 type which was shown in the original circuit (page 261, December RADIO-CRAFT). He is using such a tube as the hybrid and reports a considerable improvement; for your edification, we herewith present a drawing which he furnished to illustrate his point (Fig. 1). We cannot praise this stunt too highly, as it shows definite, original thinking. It is such development as this that the Co-Op. Lab. is endeavoring to encourage. Mr. Lowther modestly says that it is simple, but we say it required head work. The performance of his addition is not so obvious on the surface; in fact, a little explanation is quite in order.

The regular Crystal-Hybrid circuit did not incorporate the grid-grounding condenser C which we have shown in dotted lines. The crystal is extremely sensitive to stray



**M**R. GRIMES has for many years been well known not only to the engineering profession, but also to constructors and experimenters. In these pages, each month, he describes the latest circuit developments in simple language.

currents, and tends to oscillate and hum unless unusual shielding precautions are taken. Furthermore, radio-frequency currents passed right on through the detector, and helped to overload the first audio tube which is coupled to the detector by a resistor. Resistance coupling, as you know, passes radio-frequency as well as audio currents, and the R.F. energy is no longer useful after the detector. The presence of Mr. Lowther's grid condenser alleviates all this, with little or no detrimental effect. You see, there is no excuse for placing anything but audio frequency on the grid of the Hybrid tube; because the crystal has been inserted to rectify the R.F. energy. And the grounding condenser is, practically, an open circuit for these audio currents, while at the same time it practically grounds the high end of the crystal for R.F. currents. The extremely high resistance of the crystal prevents this condenser from short-circuiting the tuning circuit which it would, otherwise, directly shunt. Good work and more power to you!

## Some Old-Timers

Speaking of the time it takes to start things, we have a letter that has just come to hand from D. E. Lawson of Wister St., Philadelphia, who presents an interesting question on shielding the crystal hybrid tube. (He refers to us as "Reflex Grimes," thereby labeling himself as one of the loyal, old-time radio experimenters. The days of our Inverse-Duplex circuits date back, probably, before many of you became interested in radio work. These circuits dragged along several years and yet, judging from the correspondence, there is only now an

awakening interest in England in the Inverse Duplex. Incidentally more letters on reflex circuits have been received from experimenters in the United States in the past four months than were received for the past four years. It begins to look as if we would have to devote some Co-Op Lab space to its most recent possibilities. It may take a hundred years more to put over the Inverse Duplex. Who knows?)

Credit goes to Michael Santomaso of Main St., Charlestown, Massachusetts, who is experimenting with the tandem tuner, working out sharper tuning circuits for crystal operation. T. H. Wyatt of Coconut Grove, Florida, is carrying on experiments with the Crystal-Hybrid and the UX-240 tube; here's wishing you luck, since receiving conditions in Florida demand a good circuit.

And say! Just listen to this one which just came in from V. H. Herndon who runs the Herndon Radio Shop of Odon, Indiana: "Well, here I come all Grimesed up again just like I used to when we first met over 3XP (an early Inverse Duplex Set), and became deep, dyed-in-the-wool Inverse Fans! Dyed so deep I doubt if it will ever be erased. How the name has been blessed, cursed and damned—thrown and kicked. No one but one of the early experimental gang will know; and then follow it through to perfection in the R. G. S. Receiver. Just to show that an Inverse fan is never down, I decided to build the R. G. S. set and, boy, how that set stepped out—and is still doing it!"

## Direct-Coupled Audio

So much for that. And now for a continuation of our development work on the direct-coupled amplifier. You will recall from our last article that we were about to discuss the application of this new amplification system to standard radio receivers. Certain points were brought out as a caution against placing the direct-coupled amplifier immediately after the radio-frequency circuit of the set. Some diagrams, which show the replacement of the standard detector tube by the first tube of the direct-coupled amplifier, have been released. While this will work, as admirably explained by Commander E. H. Loftin and Mr. S. Y. White—the two eminent pioneers in this line of experimentation—it is necessary that you know of certain limitations in advance, or you are liable to encounter difficulties.

In the first place, your present radio receiver has been adjusted to operate on a definite type of detector, and the radio-frequency input to this detector is different with every type of detector tube. Figs. 2 and 3 have been included herewith to illustrate this point. Fig. 2 shows the conventional grid leak detector which functions best with a slight positive potential on the grid, indicated by a "C" battery. Such a

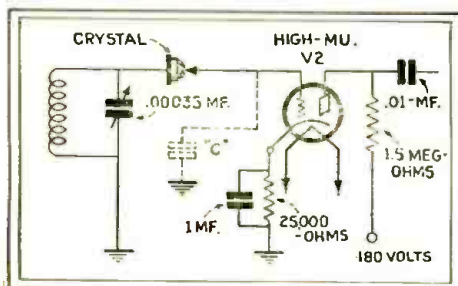
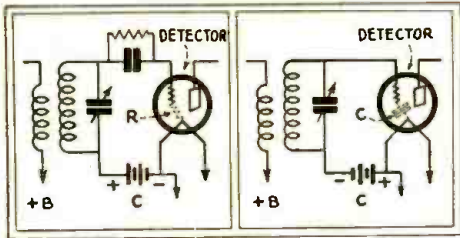

Fig. 1

A suggested improvement upon the Crystal-Hybrid circuit is the introduction of the R.F. by-pass condenser "C" between the crystal and the hybrid.



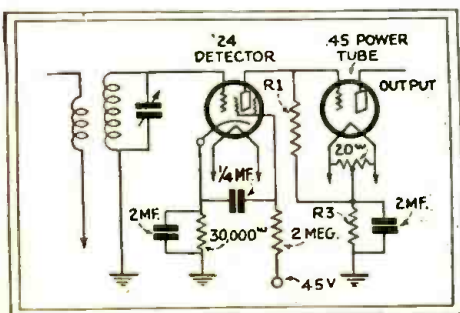

**Fig. 2** With a positive voltage on the grid, a tube acts as a high resistor; with a negative bias, its inter-element capacity makes it a small condenser.

positive voltage on the grid makes this circuit present a resistance between the grid and filament, as indicated at "R." With "C"-bias operation, as presented in Fig. 3, the grid-filament circuit offers a pure capacity, illustrated by "C" within the tube. You see, the grid draws no current in the negative-"C"-bias system, and the tube remains a true condenser; but in the grid-leak type, the grid becomes a small plate and draws current, thus creating conductivity across the tuning circuit which works into the detector.

Now, most radio-frequency circuits which were designed to work into the grid leak detector have been so arranged as to rely on this grid-filament resistance as an oscillation dampener. Such radio circuits will oscillate hopelessly if the grid-leak detector is replaced by a "C"-bias detector, which offers no loss in the tuning stage of the detector input. Hence, if your present set incorporates a grid-leak detector, it is unwise to switch this detector precipitately for the first tube in the Loftin-White system, unless you are prepared to experience some oscillation troubles. The first tube in the direct-coupled amplifier really acts as the "C"-bias detector when the amplifier is connected directly to the radio-frequency system.

Fig. 4 should be studied in connection with the employment of the direct-coupled Loftin-White system as the detector-audio circuit of your set. Here the screen-grid tube has been employed as the detector-first audio combination, working directly into the single '45 type power tube; and this fact brings up another precaution which should be taken. Extensive tests have already convinced most of the experimenters that the '24 tube is better, in the Loftin-White first stage, than the lower-gain tubes such as the '27. Now, this '24 tube has a different input grid-filament capacity from that of the '27; the same observation applies to the battery types, in comparing the '22 with the '01-A. (This input grid capacity



**Fig. 4** A screen-grid tube may be used as a power detector, direct-coupled to a power tube. In fact, here is a complete receiver.

has already been indicated, at "C," in the tube in Fig. 3.) It is necessary to remember that this tube capacity is directly across the tuned circuit and thus acts as a small additional condenser supplementing the tuning condenser. Thus, the actual setting of the tuning condenser will depend on the magnitude of the tube capacity across the tuning circuit.

This point is very important in a radio receiver which employs a gang condenser for tuning. The gang with the small midget condensers has been properly adjusted for these tube capacities. Now we suddenly shift to a detector tube with an internal capacity quite different from that of the standard tube. What is the inevitable result? The last condenser in the gang is no longer properly set to run in synchronism with the rest of the units. Of course, it may be readjusted; but you must realize that such a difficulty will be encountered, or it will not be corrected and you will wonder what your difficulty is. If separate

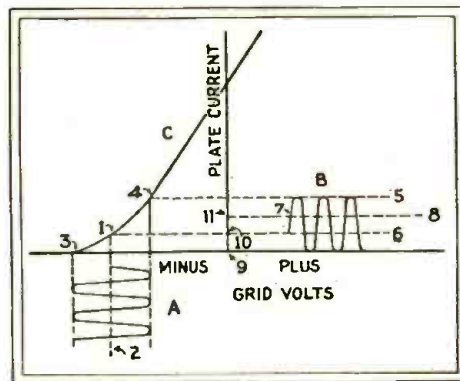

**Fig. 5** The characteristic curve of a '24-type screen-grid tube, acting as a detector. An increased signal tends to decrease the output of a direct-coupled power tube.

tuning condensers are utilized, or if only one tuned circuit is connected directly to an antenna, none of the above troubles will be experienced. It is really quite surprising to note the satisfactory reception possible with just one tuned stage. The results will be confined to local stations; but the selectivity is pretty fair, and the volume and quality is excellent. This much is to be said in favor of the direct-coupled system.

**What is "Drift"?**

Still difficulties loom up in the background. You may think that we are trying to discourage you in your efforts to try out the direct amplifier, but we are merely trying to start you off so that you can avoid the pitfalls. One of the important peculiarities of the Loftin-White amplifier, when the first tube is used as the detector as well as the first audio stage, is the tendency for the various grid and plate voltages to depart from the established values whenever the radio receiver is tuned in on a strong station. This is commonly referred to as "drift." It is not important unless two or more good stages of R.F. amplification are employed and the station is of some strength. Many of the experimenters have not noticed it at all; while others have obtained inferior results on their favorite programs, and have prematurely blamed the system.

The problem of drift requires a study of

Fig. 5. Here is shown the plate-current characteristic of the '24 operating as the detector. The grid input voltages are applied at the lower knee of the curve, in order to emphasize the detecting function; but it must be kept in mind that the curve is bent all the way up, and that detection takes place even further up the slope where the tube is normally operated as an audio amplifier. The incoming signal is indicated at "A." The normal plate current (before the station is tuned-in) in the '24 is represented by the line 1-6. This plate current, flowing through the plate-coupling resistor, supplies the grid bias for the power tube, as discussed in last month's article. The grid bias on the power tube controls the amount of plate current in the power plate circuit. Now, it should be obvious that the incoming signal, upon being rectified in the plate circuit, will increase the average plate current to the line shown at 11-8. This change in the average plate current in the detector has long been known. In a grid-leak system, the plate current decreases upon tuning into a strong signal; while the reverse takes place with the "C"-bias detector. When this plate current in the '24 tube increases, the current drop in the plate coupling resistor and, consequently, the negative bias on the grid of the power tube both increase. In turn, this increased bias decreases the plate current in the power tube and, if the bias is carried far enough by a large signal, the plate current may be reduced to a very small amount. The efficiency of the output tube under these conditions would be very much compromised.

**An Easy Remedy**

Mr. White has devised some very ingenious circuits for minimizing this effect, but our advice is to stick to a simpler procedure. All of the above troubles can be avoided if the direct-coupled amplifier is inserted after your present detector circuit. Fig. 6 shows a possibility in this connection; here the detector works out into a standard resistance-coupled stage. If you are at present using a grid-leak detector, the value of the plate resistor will be in the neighborhood of 100,000 ohms. A "C"-bias detector, on the other hand, will require a somewhat higher value—around one-half megohm—to give good audio quality. The '24 high-gain tube has been replaced by the '27; for the detector affords some amplification, and the full amount would be unnecessary if the '24 were retained. (The exact resistance values have not been placed on the drawing; because this might lead

(Continued on page 661)

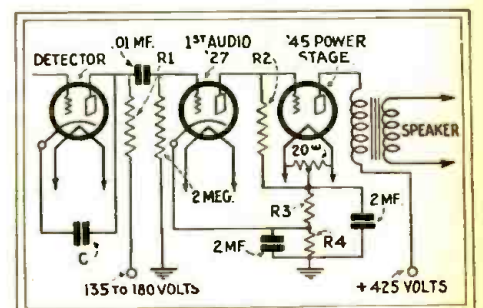

**Fig. 6** With a detector of ordinary type, and a first audio stage of ordinary amplification, many of the undesired reactions possible in a direct-coupled system are avoided.



# INFORMATION BUREAU



### SPECIAL NOTICE TO CORRESPONDENTS: Ask as many questions as you like, but please observe these rules:

Furnish sufficient information, and draw a careful diagram when needed, to explain your meaning; use only one side of the paper. List each question.

Those questions which are found to represent the greatest general interest will be published here, to the extent that space permits. At least five weeks must elapse between the receipt of a question and the appearance of its answer here.

Inquiries can be answered by mail only when accompanied by 25 cents (stamps) for each separate question. Other inquiries should be marked "For Publication," to avoid misunderstanding. Replies, magazines, etc., cannot be sent C. O. D.

### "AMBASSADOR FOUR"

(63) Mr. A. G. Smith, Daly City, Cal.

(Q.) If it is possible, I would like a circuit diagram of the "Ambassador Four" receiver altered to use a screen-grid tube in the position of the first stage of R.F. I have assembled about eleven of these sets and every one of them is working very well; and, with a screen-grid tube properly incorporated in the circuit, the results should be even better.

(A.) "Before" and "after" diagrams of the "Ambassador Four" showing the manner of connecting into circuit a screen-grid tube, are shown in this department. (Fig. Q63.)

The electrical values of the parts used in this set are as follows: C1, C2, .0005-mf.; C3, .001-mf.; C4, .00025-mf.; C5, 2 mf.; C6, .01-mf.; C7, 0.25-mf.; C8, 0.25-mf.; R1, 30 ohms; R2, R3, R4, filament ballasts of the "one-tube" type; R5, 2 meg.; R6, 15 ohms tapped at 10 ohms. T1, T2, the A.F. choke, and C5 are the usual audio components.

The constants for L1 and L2 are as follows: L1, 6 turns of No. 26 D.S.C. wire on a tube 2 3/4 in. in diameter, for the primary, and 26 turns of the same size wire for the secondary. L2 has a 6-turn primary, center-tapped, wound on a 2 3/4 in. form; a 26-turn secondary; and a 14-turn tickler, the latter wound on a rotor 1 1/2 in. in diameter. The distance between primary and secondary should be about 5/16 in. It is recommended that, if convenient, the primary of L2, when used with a screen-grid tube, be increased to 10 or 15 turns; the value depending upon the selectivity required by local reception conditions.

The only changes required in the circuit connections of the old receiver are indicated at the left of the larger schematic; the part of the latter to which the smaller diagram relates is set off by a dotted outline.

Comparing notes, it will be seen that the center tap on the primary of L2 is not used and C6 is no longer required. An added "B" tap is shown, supplying the screen-grid with its required potential of about 45 volts (of course, if the detector works well with the plate held at the same potential, only one "B" tap is required). The by-pass condensers C7 and C8 are absolute requirements; the low-voltage filament requirements of V1 are met by adding R6 to the circuit which provides also a small "C" bias

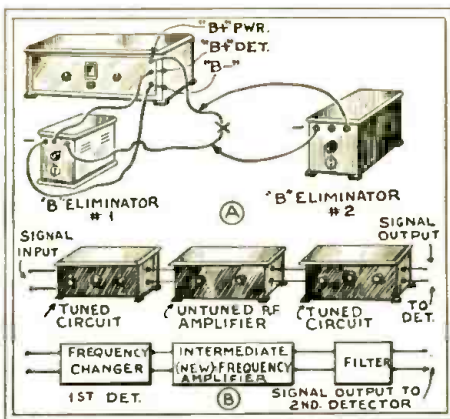

Fig. Q64. Above, how to connect "B" units in series like batteries; care must be taken that the units have not a common ground. Below, the pre-selector and superheterodyne systems, compared.

for the control grid through the voltage drop across it.

Whether shielding is required for the circuits of V1 must be determined by experiment. Because of the rather large dimensions of the Ambassador coils, really good shields must of such large proportions that they are inconvenient to install in most sets; but a compromise, in size, may be secured by careful attention to the fundamentals of shielding. It is possible that the limited degree of shielding afforded by a vertical aluminum or copper plate, between the components of the first and second stages would be sufficient to prevent circuit oscillation due to over-all feed-back.

It should be noted that certain "Ambassador" A.F. transformers are wound with resistance wire; as a result, the "B" supply necessary to obtain approximately the voltages indicated in the diagram at the plates of the A.F. or detector tubes, must have, at the taps, voltages greater than those shown in the diagram. Of course, a check of the plate po-

tentials with a high-resistance voltmeter will immediately indicate the voltages actually present at the plates of these tubes. The grid voltages do not require to be other than as specified, unless the tubes have characteristics that are a bit erratic; a milliammeter in the plate circuits will check this possibility.

### ADDING ELIMINATORS—SHORT-WAVE PHONE—UNTUNED AMPLIFICATION

(64) Mr. William Bell, Windsor, Pa.

(Q.) Can two "B" eliminators, each delivering 180 volts, be hooked up to deliver 360 volts?

(A.) The manner of connecting two alternating-current "B" units to obtain the total output is shown in Fig. Q64. The high-voltage lead to the set is broken at X and the second "B" supply connected into circuit; the highest positive lead of the first unit is joined to the negative lead of the second.

Before connecting the increased output to a receiver, the latter should be examined to determine whether the by-pass condensers within the set, from "B+ Max" to "B—" are capable of operating at the increased potential.

(Q.) Why is it not possible to receive distant programs at night on five meters?

(A.) Wavelengths in this region have not been assigned to broadcast service, and there are no programs. Experimental work is being carried on, at wavelengths of five meters and less, both by code and by phone; however, at such high frequencies, absorption of the wave is very rapid, and satisfactory transmission is possible only when the radiations are focused like the rays of a searchlight. As most of the signals are thus concentrated into the form of a "beam," it is difficult to receive except in this one direction, and within a comparatively short distance of the transmitter. The paths followed by these extremely short waves are not yet thoroughly understood; and special receivers are necessary for their reception.

(Q.) After reading the description of the "1930 Electric" receiver in your November issue, the question arose in my mind, whether the idea of untuned stages could be applied to other receivers. Please answer whether a superheterodyne, for ex-

(Continued on page 668)

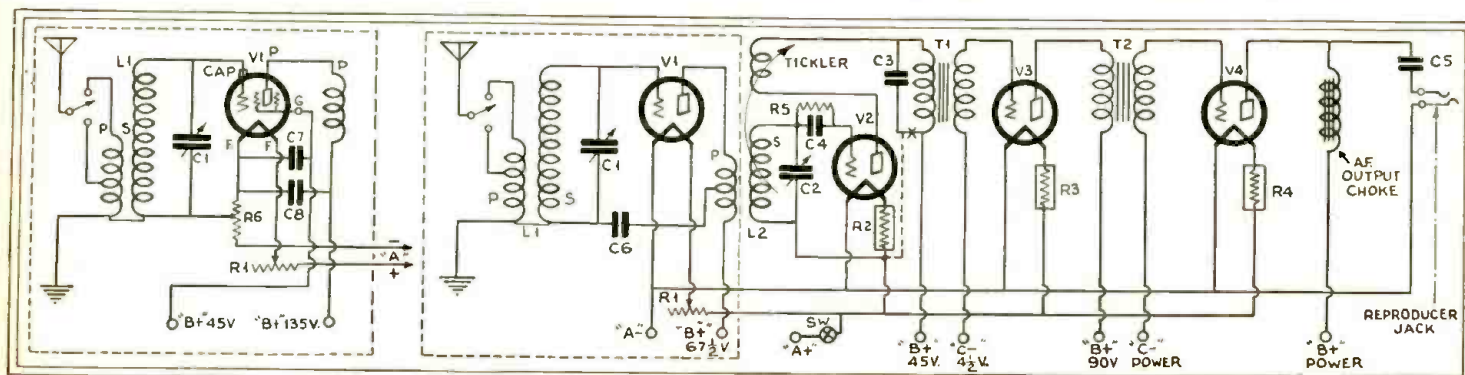

Fig. Q63. At the right, the "Ambassador Four" receiver as originally designed. Its first R.F. stage, indicated by a dotted square, may be replaced by the screen-grid stage shown in the dotted panel at the left. Necessary changes are described in the text.





**Open this  
FREE BOOK**

*and you open  
the door to*

**SUCCESS**  
*in*

**RADIO**

**Y**OU, too, can be trained for a big-time radio job . . . Clip this coupon now and send for this **FREE BOOK** . . . Read it page by page . . . see for yourself why thousands of fellows just like you are now making from \$50 to \$100 a week. This free book gives you 40 fascinating pages of pictures and text, all about RCA Institutes, the only school that is endorsed by the Radio Corporation of America . . . The school that actually sends you radio instruction direct from RCA . . . the very source of radio achievement!

**Easy to Learn Radio  
At Home in Your Spare Time**

Let the RCA Institutes Home Laboratory Training Course give you the real inside facts of radio . . . quickly and easily. Use your spare time to train for success with the remarkable

outlay of screen-grid apparatus given to every student of this course. You learn how to solve every radio problem such as installing, repairing and servicing fine sets. This is the training that will help *you to make money in radio!*

**RCA Graduates in Big Demand**

For more than 20 years, there has been a well-paid position in Radio waiting for practically every graduate of RCA Institutes. This is a record unequalled by any other school. Only the vast resources of RCA could give you this practical training . . .

**Send for this Free RCA Book  
"Radio . . . the Field  
of Unlimited Opportunity"**

Start today on the road to Success in Radio . . . Send for this **FREE BOOK**. Every page is packed with pictures and text telling you all you want to know about RCA Institutes, the oldest and foremost Radio training organization in the world. Radio can easily be **YOUR ROAD TO SUCCESS** . . . That's why you should

**Clip this Coupon NOW!**

**RCA INSTITUTES, INC.**

A Division of  
Radio Corporation  
of America



RCA INSTITUTES, Inc.  
Dept. RC-6, 75 Varick Street, New York

Gentlemen: Please send me your **FREE 40-page book** which illustrates the brilliant opportunities in Radio and describes your laboratory-method of instruction at home!

Name.....

Address.....



# Radio Books

by JOHN F. RIDER

have found popular appeal. They have proved of extreme value to the service man and the experimenter because they are written specifically for the practical radio worker in language he can understand.

## "THE MATHEMATICS OF RADIO"

is a simplified version of the mathematical problems encountered in practical radio work. Price, \$2.15 postpaid. 128 pages.

## "THE TROUBLE SHOOTER'S MANUAL"

is a book for the service man and experimenter, replete with practical trouble shooting information and contains about 150 wiring diagrams of old commercial radio receivers. Price, \$3.50 postpaid. 240 pages.

## "THE TREATISE ON TESTING UNITS"

contains wiring diagrams of modern service equipment. Price, \$1.10 postpaid. 48 pages.

## WIRING DIAGRAMS

package number 1 supplement to John F. Rider's "Trouble Shooter's Manual" is now ready for distribution. Here is an opportunity to secure wiring diagrams of the modern screen grid receivers at a ridiculously low price. 115 wiring diagrams, size 8½ in. x 11 in. punched three holes suitable for loose-leaf binding, covering screen grid receivers produced by such manufacturers as Grebe, Crosley, Stromberg-Carlson, Fada, Stewart-Warner, Edison, Eveready, Silver-Marshall and others. Price, \$2.50 postpaid. Write for list of diagrams and books.

**RADIO TREATISE CO., INC.**  
1440 Broadway New York City

Coupon

**RADIO TREATISE COMPANY, Inc.,**  
1440 Broadway, New York City.

- ...Send me Rider's "Math of Radio" and I will pay postman \$2.15 plus a few cents for service charges.
- ... Send me Rider's "Trouble Shooter's Manual" and I will pay postman \$3.50 plus a few cents for service charges.
- ... Send me Rider's "Testing Unit Treatise" and I will pay postman \$1.10 plus a few cents for service charges.
- ... Send me "Wiring Diagram Package No. 1" and I will pay postman \$2.50 plus a few cents for service charges.
- ... Send me the "Trouble Shooter's Manual" and the Diagram Package and I will pay postman \$5.50 plus a few cents for service charges.

It is understood that if I am not satisfied, I may return the above within 10 days and get my money back.

NAME .....

ADDRESS .....

CITY ..... STATE .....

# Servicing with a Set Analyzer

(Continued from page 630)

### Other Features

Referring now to the accessories designated by letters, we find they may be used as follows:

A and B are to test A.C. line-voltages, through cord 1 (Fig. A); after the test is made this must be removed, or the plug pulled from the line socket. Line supplies above 120 volts may be read by connection to the higher voltage terminals available; and polarity, as well as A.C. or D.C. characteristics, may be checked by the use of the D.C. meter in conjunction with the A.C. meter. Posts E and F will be used in this check.

C and D are to measure low A.C. or D.C. external potentials as indicated in Fig. 2, using test leads 2 (Fig. A) for the purpose.

D and E measure up to 60 volts D.C.; E and F from 120 to 600 volts, D.C., by pressing the correct button.

F and G measure current ranging from 12 to 300 ma., after pressing buttons as previously described for tube tests.

J and K are used to connect the 4½-volt battery, which is introduced into circuit when button No. 13 is pressed. (In making tube tests this cuts down by 4½ volts the effective potential in the grid circuit; as this voltage is positive on the grid side.) This battery serves also to provide potential for continuity testing; a jumper is run from its positive terminal to binding post D, one of the test leads No. 2 (Fig. A) is connected to the negative terminal of the battery, and the other to binding post C. After locking down button No. 7, the meter should give a reading when the two test leads are brought together.

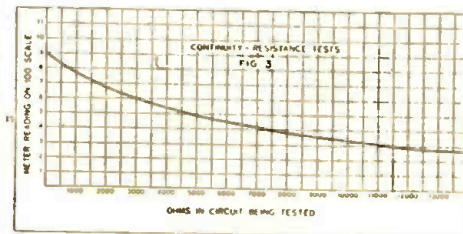

A chart from which resistance values may be read on the 0-12 D.C. voltmeter scale. The 4½-volt battery is used for this.

### Resistances and Capacities

Resistor values may be determined from the table (Fig. 3) reproduced in these columns, in which the 0-12-scale is used. On this, the needle will indicate 9, when a 4½-volt battery is used and the test leads shorted. A resistor under test is checked by use of the test prods.

For condenser tests, the 8-volt scale on the A.C. meter is used; with one side of the secondary of a step-down transformer delivering about 5 volts (about 5¾ volts, open circuit) connected to post C, button No. 2 locked down, one test lead connected to binding post D, and the other to the remaining transformer-secondary lead. When these leads are brought together the meter should read about 5¾ volts. When condensers are introduced into circuit the voltage will drop to a reading which depends upon the ca-

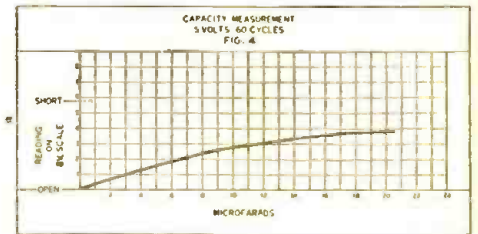

With a transformer delivering about 5 volts, alternating current, capacity values may be determined from the chart above and the readings of the A.C. meter.

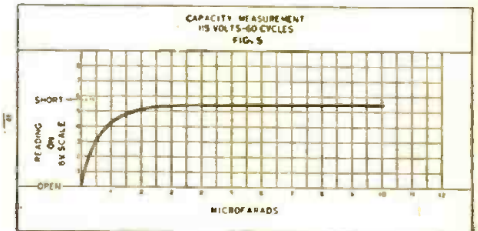

With the smaller condensers, more accuracy is obtained by the use of the full A.C. line-voltage and this lower chart.

capacity of the condenser. This particular set-up is good with condensers from 20 mf. down to 3 mf., as shown in Fig. 4; lower values are tested in the same way but with a line-voltage of 115, posts A and B used (instead of C and D) and no buttons locked down. Fig. 5 is the corresponding table.

A precaution against damaging the instruments is always to start with the highest milliamperage or voltage reading obtainable on the analyzer; and then press buttons for lower ranges until the needle deflects on the scale most easily read. This method automatically guards against excess voltages, in certain circuits, due to defects within the instruments under test.

## Study for Service Men

(Continued from page 618)

are also allied with that grid-bias resistance and furnish additional current, which flows through the resistance and helps to develop the correct bias voltage.

Service today needs the man who will investigate modern circuits, will learn their "innards," and will remember that defects in radio receivers are no longer limited to the parts used in the old-type, simple grid and plate circuits. All radio-frequency systems are not transformer-coupled, tuned or untuned. All capacity-coupled installations are not coupled through a fixed condenser; instead the capacity present between two coils, one of which is open-ended, is used in many of the late Atwater Kent A.C. receivers.

Many imagine that continued reference to wiring diagrams is the order of the day; no such thing. It is only necessary to remember that many units, other than the conventional parts of a grid or plate circuit, may create the defect; that is if they are used. It then becomes necessary to investigate whether such special circuits are actually in use.

One is accustomed to certain forms of



screen-grid radio-frequency systems. All design engineers do not think along similar lines; hence the receivers produced by different manufacturers are actually different, and data upon one are not necessarily applicable to the other. Further investigation is necessary to learn the many systems in use. "Local-distance" circuits do not always involve changes in the number of turns used in the primary of the radio-frequency transformer, nor resistors connected across the primary. In many instances, this control represents a fixed resistance which is inserted or removed from a tuned circuit.

Yes, by all means study new circuit structure. Spend a good deal of time analyzing new wiring diagrams. It will prove very illuminating, and will save a good deal of time and trouble later. It is actually money-saving, as well as educational, activity.

## The Service Man's Forum

(Continued from page 625)

another magazine states "it is obvious that effective transoceanic short-wave reception cannot be accomplished through an ordinary aerial system, as some interests would have you believe?"

JERRY DONOVAN,  
Waterloo, Iowa.

(Several thousand short-wave fans will take issue with this statement; which is, however, true from the standpoint of a broadcast engineer, whose standard of efficiency is that obtained by transmission of programs over special wire lines. Special directional antennas are built by the transatlantic communication companies to receive short waves from a specified transmitter; the location gives an advantage of fifty to one, sometimes, over ordinary location. Then, the antenna used is several hundred times as receptive as an ordinary short, non-directional aerial. Nevertheless, even with these things and a costly, carefully-engineered receiver, fading and static may bother the broadcast engineer until he despairs of announcing a transatlantic program in advance.

On the other hand, with a much less satisfactory location, an ordinary aerial and a simple set, the short-wave broadcast fan enjoys a good deal of very interesting reception, often at loud-speaker strength, from great distances. He cannot be certain of a given station, year in and year out, with local quality; but he will get a good deal of enjoyment out of a good short-wave receiver, if his location is at all good, and he can get the "DX" or long distance which most owners of standard sets have quit trying for.—*Editor.*)

### MORE EXCLUSIVE FRANCHISES

*Editor, RADIO-CRAFT:*

The average dealer looks upon service as a necessary evil, and he is about right under present conditions. (I sold Crosley radios for three years; but, after the Crosley Radio Corporation abused their franchise and let cut-rate stores carry the product, I quit selling and went in for servicing.) I hope the situation will clear itself in the future, but cannot see an indication so far that it will.

Two of our largest manufacturers sell either directly or indirectly to the cut-rate

# PATENTS INVENTORS



Write for these  
**FREE BOOKS!**



At the left is a view of my drafting and specification offices where a large staff of experienced experts is in my constant employ. All drawings and specifications are prepared in my offices.

## Protect Your Ideas Take the First Step Today

If you have a useful, practical, novel idea for any new article or for an improvement on an old one, you should communicate with a competent Registered Patent Attorney AT ONCE. Every year thousands of applications for patents are filed in the U. S. Patent Office. Frequently two or more applications are made for the same or substantially the same idea (even though the inventors may live in different sections of the country and be entirely unknown to one another). In such a case, the burden of proof rests upon the last application filed. Delays of even a few days in filing the application sometimes mean the loss of a patent. So lose no time. Get in touch with me at once by mailing the coupon below.

### Prompt, Careful, Efficient Service

This large, experienced organization devotes its entire time and attention to patent and trademark cases. Our offices are directly across the street from the U. S. Patent Office. We understand the technicalities of patent law. We know the rules and requirements of the Patent Office. We can proceed in the quickest, safest and best ways in preparing an application for a patent covering your idea. Our success has been built on the strength of careful, efficient, satisfactory service to inventors and trademark owners located in every state in the Union.

### Strict Secrecy Preserved— Write Me in Confidence

All communications, sketches, drawings, etc., are held in strictest confidence in strong, steel, fire-proof files, which are accessible only to authorized members of my staff. Feel free to write me fully and frankly. It is probable that I can help you. Highest references. But FIRST—clip the coupon and get my free book. Do THAT right now.

### No Charges for Information on How to Proceed

The booklet shown here contains valuable information relating to patent procedure that every inventor should have. And with it I will also send you my "Record of Invention" form, on which you can sketch your idea and establish its date before a witness. Such evidence may later prove valuable to you. Simply mail the coupon and I will send you the booklet and the "Record of Invention" form, together with detailed information on how to proceed and the costs involved. Do this NOW. No need to lose a minute's time. The coupon will bring you complete information entirely without charge or obligation.

**Clarence A. O'Brien**  
Registered Patent Attorney

Member of Bar of Supreme Court of the United States; Court of Appeals, District of Columbia; Supreme Court, District of Columbia; United States Court of Claims.  
Practice confined exclusively to Patents, Trademarks, and Copyrights



Mail this Coupon Now

**CLARENCE A. O'BRIEN**  
Registered Patent Attorney

3503 Security Savings and Comm'l Bank Bldg.,  
Washington, D. C.

— or —  
Suite 1106, Woolworth Bldg., New York City

Please send me your free book, "How to Obtain a Patent," and your "Record of Invention" form without any cost or obligation on my part.

Name .....

Address .....

(Important: Print or Write name clearly  
and address office nearest you)



# Announcing!



50c

The Copy

On All Large Newsstands

HERE at last is the one and only REAL big magazine on short waves you have wished for so long.

Chock full with short-wave dope for the "ham," the amateur, the experimenter, the professional.

Over 250 illustration, hook-ups, charts, circuit-diagrams and actual photos of receivers, transmitters and practical stuff.

Filled to the brim with honest-to-goodness "meat"—not a picture book, no mathematics, no theories that are over your head—PRACTICAL dope, live meat—that's what you want—and get.

100 big pages, 9 by 12 inches, printed on a heavy grade of book paper, with a beautiful cover in four colors — that's SHORT WAVE CRAFT.

Contains more material than a \$2.50 book, yet the price is but 50c. a copy.

PUBLISHED ON THE 15th OF EVERY OTHER MONTH

Edited by Hugo Gernsback, originator of the world's best radio magazines, such as MODERN

ELECTRICS, RADIO NEWS, RADIO-CRAFT, etc.

Mr. Gernsback has marshalled together the greatest short-wave experts, and they will write right along for SHORT WAVE CRAFT.

Not only that, but he has imported articles by German and French short-wave authorities. Most of this material has never appeared in print in America.

Just glance at the contents of the first issue and be convinced.

## Special Feature Articles in Vol. 1, No. 1 of SHORT WAVE CRAFT

By these Internationally renowned authorities

Laurence M. Cockaday    Robert Kruse    "Bob" Hertzberg    Sylvan Harris  
Dr. Lee de Forest    John L. Reinartz    David Grimes    H. G. Cisin

## A FEW OF THE MANY OTHER ARTICLES:

- Hertzian and Infra-red as a Means of Communication, by Dr. Fritz Schroter (translated from the German)
- Short Waves in Medicine—Their Effect on the Human Body, by Dr. Schliephake (from the German)
- Ten Centimeter Waves, by Dr. Ernst Gerhard (from the German)
- Five Meters or Bust! by Clyde Randon
- A New Magnifying Short Wave Tuner
- A Treatise on Short Waves, by Dr. Bley (from the German)
- Bringing Old Short Wave Receivers Up to Date, by "Bob" Hertzberg
- Transoceanic Short Wave Transmission and Reception
- Importance of Smooth Regeneration and How to Obtain It in the Short Wave Receiver
- Short Wave Receivers—Simple as Well as Elaborate Receiving Sets
- Short Wave Transmitters—How to Build Them for Various Wave Lengths
- Television on Short Waves—Design and Construction of Receivers
- Short Wave Converters for Broadcast Receiving Sets
- Aircraft Receivers and Transmitters

## REGULAR DEPARTMENTS IN SHORT WAVE CRAFT

- Photographic Section—pictures of latest short wave sets and stations
- Transmitters for Short Waves—How to build them
- Short Wave Receivers—construction data for all types and kinds
- The Short Wave Experimenter
- The Short Wave Beginner
- Television on Short Waves
- Aircraft Short Wave Sets
- Ultra Short Waves
- Short Waves for the Broadcast Listener
- How to Build Short Wave Aerials
- How to Tell the Time in Various Parts of the World
- Short Wave Question Box

The first issue of SHORT WAVE CRAFT will be on the principal newsstands on May 15th. As the magazine is widely advertised be sure to tell your news dealer to reserve your copy.

CLIP COUPON TODAY!

## SPECIAL OFFER!

During the month of MAY ONLY, we are accepting Charter Subscriptions at a specially reduced rate of 40%. This offer is void after May 31st. Take advantage of this money-saving opportunity and fill out the coupon.

RADIO PUBLICATIONS, Inc.  
96-98 Park Place, New York, N. Y.

RADIO PUBLICATIONS, Inc. RC-6  
96-98 Park Place, New York, N. Y.

As per your special introductory offer in RADIO-CRAFT, please enter my subscription for one year to your new publication, SHORT WAVE CRAFT. I understand that the regular subscription price is \$3.00 but that up to May 31st the price to Charter Subscribers will be \$1.80, for which I enclose remittance herewith. (\$2.00 Canada and Foreign.)

NAME .....

ADDRESS .....

CITY..... STATE.....

chain stores, though they have authorized dealers in the same towns. The cut-rate stores are very apt to substitute cheaper tubes, batteries, etc.; thereby increasing their profits and enabling a larger margin of allowance on trade-ins.

The manufacturers' reason for winking at the stores which sell on a cut-rate basis is that the latter sell many more sets than the regular dealer; and the manufacturers do not care a hoot who sells them as long as they can keep up the production.

Manufacturers state that the average Service Man is not sufficiently versed in their product to service their sets satisfactorily; but they will overlook the man who puts any old kind of tubes in their sets and the cheapest kind of accessories, instead of what they recommend.

The independent Service Man is up against a tough proposition in regard to replacements from the factory. Manufacturers claim that he should buy through the jobber; but very often the jobber does not carry the article in stock, so there is another delay. Manufacturers will not recognize a C. O. D. order from the Service Man for replacements; and the latter in most cases has not a price list of parts available to simplify matters.

We need a whole lot more cooperation between manufacturers, dealers and service organizations; the right kind of exclusive dealer franchises that will give a dealer the chance to give his Service Man the necessary training on the set he is handling; and the elimination of the cheap accessory stores and their methods. Then, and then only, will sales and service go hand in hand as they should, the public get real service, and a good profit be shown for all concerned.

Roy Douglass,  
Hastings, Michigan.

## TIME PAYMENTS AND THE CUSTOM BUILDER

Editor, RADIO-CRAFT:

It is indeed a shame the way the custom set builder has been shunted out of the once profitable field. I believe every custom set builder who could produce the goods would be still in the game, were it not for one thing—time payments. It was the "10% down" terms offered by almost every store that killed the golden goose, and not the cheapness of the standard radio set. If only a way could be found of financing the custom set builder, or discounting his customer's notes, we would still be going strong.

I have offered a very elaborate job, slightly above cost, only to be told: "I'd take your set ahead of any I have ever heard, if you could arrange time payments."

The only way I can exist now is to buy "as is" junk on Radio Row, repair or rebuild it, and sell it for less than \$50 with dynamic speaker—make about ten dollars and do twice the talking that it would need to sell a set three years ago on which I made a hundred-dollar profit. I have to sell six sets a week, or go back to my old trade.

If a way can be found to sell on time, what a boost it would be to us remaining few who have been making a living at this since 1922. Why not say something about this in the next number of RADIO-CRAFT?

WILLIAM THOMEE,  
Mount Vernon, N. Y.



## Operating Notes

(Continued from page 624)

was reduced, but the electrical center tap of the filament was disturbed, causing a hum that was difficult to locate. The easiest way to overcome this is to use two resistors, placing one in either filament leg.

Hum, in the Fada "25" and "35 A.C." models, has been traced to the method used to fasten the common terminal of the filter block to the chassis; this is purely a mechanical connection (that is, by screw and nut) which works loose, making bad contact between lug and chassis. Also, in the same models, examination of the rubber-covered leads coming from the filter block will not be amiss; as these leads sometimes short and cause a hum.

Testing for bias or cathode voltage on indirect-heating tubes (such as the '24 and '27) with a high-grade set analyzer is sometimes misleading; for the resistance of the meter bridges the open and the effect of an open biasing resistor is lost. The writer uses a continuity meter, made of a low-range meter (125 ohms per volt) in conjunction with a 4½-volt battery to test bias resistances. Testing from cathode to chassis will show up open resistors on '27 and '24 tubes; test from each filament terminal to chassis on '26, '71A, '10, '45 and '50 tubes. This method will also show up center-tap filament resistors which have one section or portion open—a condition that will cause an abnormal hum in the set, that is difficult to locate. (Fig. 5.)

### Miscellaneous

A complaint of fading reception in the Colonial "32 A.C." has been traced to the 0.1-mf. blocking condenser in the resistance-coupled stage. This condenser open-circuits, but does not change any of the voltage constants of the set. The only remedy is replacement.

In the Bosch "Little Six," the compensating condensers are aluminum plates situated in front of the tuning condenser gang and near the panel. Constant banging of the condenser gang causes these plates to shift, and short that particular variable condenser. These compensating plates are not noticeable, and many Service Men do not even know that they are utilized in this model.

The complaint of mushy and intermittent reception on the Victor "32," and other models using the same chassis, has been traced several times to the carbon resistor connected across the grid condenser; this grid leak works loose from its metal connectors, which encircle the ends.

The cause of failure of the '80 rectifying tube, in the Zenith "50" series which uses an automatic tuner, may be the pilot-light arrangement in the tuner. If the socket shorts, the '45 filament winding is shorted; and this places such a load upon the power transformer that the '80 rectifier sometimes goes "west."

### A GRADED RADIO TAX

AUSTRIA, like other countries, charges a license fee on radio receivers; but unlike others, bases the amount on the set owner's income. Those who have an income less than \$100 a month pay 85 cents a month; others one-third of that amount, for the privilege of listening.

# N.Y. ELECTRICAL SCHOOL Men Graduate into many fields...



AVIATION  
ELECTRICITY

AUTOMOBILE  
ELECTRICITY



NAUTICAL  
ELECTRICITY



ELECTRICAL  
ENGINEERING



A full knowledge of electricity, as taught in the New York Electrical School, makes you independent, gives you your choice of either a **BIG PAY** job with one of the world-famous electrical companies, or a business of your own. **ELECTRICITY** is also a stepping-stone to Aviation, Automobile Engineering and other highly paid professions.

Here at the New York Electrical School you learn, not by correspondence, but by **ACTUAL PRACTICE** on full-size standard equipment. **NO BOOKS** used. Individual instruction—you can start any day. This School owns and occupies two seven-story buildings in New York—the city of most opportunities. It is widely known as the country's oldest and foremost institution for trade training. That's why big companies eagerly demand our graduates.

## THE NEW YORK ELECTRICAL SCHOOL

21 West 17th Street, New York



**FREE**

This big 64-page booklet gives full information about the New York Electrical School courses and picture of the equipment available for your personal use. Send for it **TODAY**. It's free.

MAIL TODAY

The New York Electrical School  
21 West 17th Street, New York

Please send me **FREE** your 64-page booklet. It is understood that this request puts me under no obligation.

Name .....

Address .....

## ELECTRAD

Time-Tested

### RESISTANCES and VOLTAGE CONTROLS

Radio engineers, manufacturers, custom-builders, service men **KNOW** that "ELECTRAD" stands for radio resistances of highest quality and most advanced engineering design. A large line of stock types for replacement purposes. Priced **RIGHT**—through modern mass manufacturing.

Write Dept. RC-6 for folder

175 Varick St., New York, N.Y.

**ELECTRAD**

## LEARN RADIO



in a school with a reputation for graduating competent men

Dormitory - Laboratory - Workshop

**SUBJECTS TAUGHT**  
Navigation Commercial Radio  
Radio Service Radio Broadcast  
Laboratory Vitaphone-Morletone  
Radio Mathematics

Write for further information

## COMMERCIAL RADIO INSTITUTE

38 W. BIDDLE ST. **FOUNDED 1920** BALTIMORE, MD.



# 10 Tools in One

A SMALL but handy article which serves for every possible need of the all-round mechanic. Invaluable in any emergency.

An excellent combination of utilities for the household—every necessity featured: HAMMER — KNIFE-SHARPENER — NAIL-PULLER — BOTTLE-OPENER — SCREW-DRIVER — CORK-SCREW — CAN-OPENER — WEIGH-SCALE — RULER — TABLE OF WEIGHTS AND MEASURES

Just glance at the illustration and you will see how really useful this article is. The "Ten in One Tool" is 10 inches high and finely nickel-plated.

The new tool is not only handy in the household, but every TOURIST, AUTO-IST, CAMPER, PICKNICKER, BOY-SCOUT, FISHERMAN, CANOEIST, etc., should carry in his bag one of these indispensable combination tools. No SHOP, OFFICE, STORE, GARAGE, FARM, BOAT, should be without one. PRICE \$1.00, POSTAGE PAID.

Be the first one to own the "Ten Tools in One" in your own town.

Send your order today, pin a dollar bill to coupon below and the shipment will go forward to you the same day order is received.

**GREN PARK COMPANY**  
245 Greenwich Street  
New York, N. Y.

Grenpark Company, FG-630  
245 Greenwich Street,  
New York, N. Y.  
Enclosed find \$1.00 for which please send me prepaid your "Ten Tools in One."  
Name .....  
Address .....  
Town..... State.....

Tempered Steel Screw Driver **\$1.00**

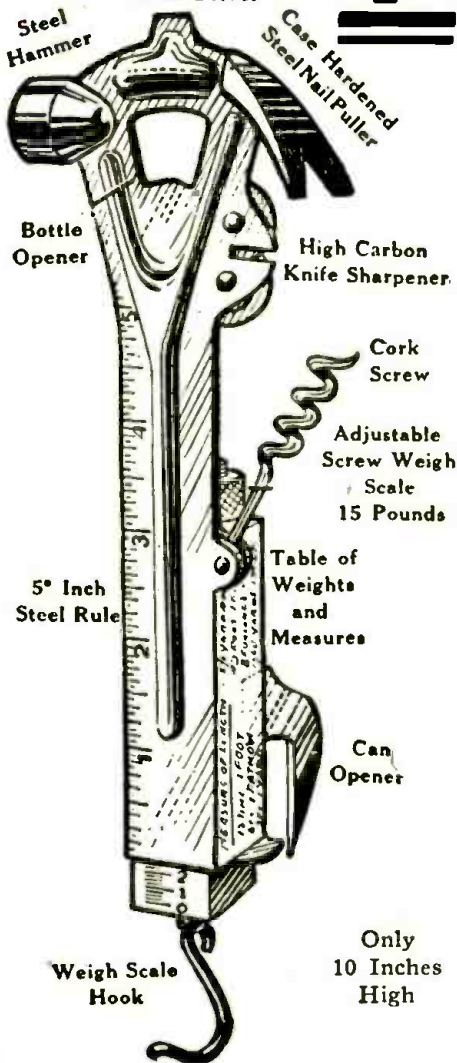

Mail Coupon  
Send for Yours  
TO-DAY

## Quick Audio Testing

(Continued from page 623)

rectly to the grid of the detector tube. The other is grounded or connected to "B-." It is therefore a simple matter to make contact with the grid of the tube by simply holding a wire, small screwdriver or any metallic object in the fingers and inserting it in the tip jack.

There are, however, some sets which do not have the pick-up attachment; in this case the difficulty can be very easily overcome by using the little instrument shown at the right; it is simply a piece of metal shaped as shown, and used by removing the detector tube, slipping the grid prong through the hole in the instrument and replacing tube in socket. By touching the device with the fingers, we now have a way of using the old-time method again.

Since the usual procedure, when the Service Man finds a set "dead" and wishes to localize the trouble, is to start with the audio end, this little stunt should prove a very useful addition to his bag of tricks.

## Service Men's Notebooks

(Continued from page 620)

might run anywhere from a few days to a few months without giving trouble. We finally decided that there must be some real trouble in the set and set out determinedly to find it. It was finally discovered that tilting the set at a certain angle would produce a short circuit which would raise the voltage on the 71A output tubes to 6½ volts; followed by the burning out of one of the tubes and, later, by the burning out of the filament resistor.

A customer having a Freshman "N" set had complained several times about loud hum. The Service Man on each visit balanced up tubes, changed detector tube, etc., and in each case left it reporting hum normal but soon after this the customer would complain that the hum was loud. After some period of time, the writer was called upon to visit this set by another complaint, caused by the set being unbalanced. At the same time I studied the question of the hum which, on arrival, was somewhat abnormally loud and in the handling of the set could be brought up to a volume that sounded like an aeroplane. The chassis slid out on a drawer from the cabinet and I noticed, on sliding the chassis out, that the hum became normal. At first I thought this was due to change of position between chassis and speaker, the latter being over the set. Then, on pushing the chassis back to normal position, I found the intensity of the hum could be changed by pushing on the back of the power pack. From this I concluded there must be a poor connection of some sort in the power pack but, as I had no authority from the customer at that time to do a job on the hum, I put a wedge underneath the power pack to settle it in a firm position in which the hum was normal. This was several weeks ago, and the set has been running O. K. since.

## THE GHOST OF A DEAD BATTERY

By Russell L. Woolley

IMAGINE my embarrassment when I tested a "Silver-tone" battery model, and found a reading of 45 volts negative on the grid of the first audio stage, when the set

# Prepare for BIG PAY Jobs! Learn Radio and Television

Organized Labor—owner of Station WCFL, Chicago—is conducting a nation-wide good-will campaign. Labor suggests the study of Radio and Television as a happy and profitable way of getting better acquainted, and makes this astounding offer:

Complete Course in Radio and Television **ALL FOR ONLY \$2**  
Handy Loose-leaf Lesson Folder  
Radio and Television Dictionary  
Large Schematic of Federation Four  
WCFL Radio Magazine for One Year

The WCFL Radio and Television Course is used as standard text in more than four hundred high schools and is also being studied by nearly 50,000 adult students. It has helped thousands to increase their earnings. **OPENS THE DOOR OF GREATER OPPORTUNITY IN RADIO FIELD.**

WCFL, 623 So. Wabash Ave., Chicago.

For the attached \$2 enroll me for the WCFL Radio and Television Course, also send me Loose-leaf Lesson Folder, Radio and Television Dictionary, Large Schematic of Federation Four and WCFL Radio Magazine for one year.

Name .....  
Street .....  
Postoffice ..... State.....

### Fighting for the Freedom of the Air

WCFL Radio Magazine is the only publication actively fighting for the freedom of the air—the gravest question now before the public. Whoever controls radio will control the Nation.



had only a small 4½-volt "C" battery connected! A month before I had equipped the set with a new Philco eliminator, and it had played perfectly. I was further assured that no one had tampered with it.

I took a complete set of readings with a standard analyzer and found them normal, except as stated above and that the plate current of this tube was enormously high; the set howled at audio frequency.

With these facts in mind, I broke open the "C" battery and found the connecting wires green with corrosion. For this reason, it was acting as a high resistor (grid leak) and causing the tube to oscillate at audio frequency; the grid voltage registered was the drop across the resistance of the dead battery. I should, of course, have changed the "C" battery before I went to so much trouble in testing; I tell this so that other Service Men may not make the same mistake.

**OLD DOC SOLDERING IRON**

By W. K. Burrows

**I**N the "Buckingham" eight-tube sets, some of which use '27s and other '21s (though built on the same chassis) the R.F. transformer terminals should be examined, if weakness on long-wave stations is found. The connection between the ends of the winding and the terminal may appear solid; yet reswearing it will result in a vast gain in volume.

**MASS-PRODUCTION TROUBLES**

By V. H. Herndon

**W**HEN you have violent oscillations in the Steinite "Model 70," look to the shields between the tuning condensers. On each are three springs which fit down over the end plates of the condensers; clean these and see that they make good contact. Examine the two wires that ground the second and fourth gangs to the chassis and, if you find a rosin joint, take this off and do the job right with a big, hot iron, well tinned and clean.

In some Crosley "Showboxes," which you have to keep jarring, the trouble will be found in little slivers of the metal of which the stator plates are cast. These curve out and touch the rotors.

**LOCATING A GROUND**

By Herbert W. Jones, W9DUH

**O**FTEN a Service Man goes on a job, and finds two wires of the same size and color passing up through a hole in the floor. To make it easy to tell which is the aerial wire (without having to trace through, go down in the basement, crawl over barrels, etc.) the following is suggested:

With an A.C. meter cord plugged into the wall socket, but only one wire connected to the meter, touch one of the pair of wires in question to the other post of the meter, and note if there is a voltage reading. If no reading obtains, touch the other wire of the pair to the meter. If no voltage is obtained with either wire, then give the socket plug half a turn, or connect the other side of the A.C. line to the meter; and repeat the test with the two wires that come through the floor. The one of the pair that shows a voltage reading is the ground wire; the other is presumably the aerial. If voltage readings are obtained from both wires, the aerial is grounded.

This little stunt saves time, and eliminates guesswork.



**SENSITIVE!**

- 4 screen-grids.
- Visibility meter.
- Equal response on high or low frequencies.
- Radio or audio switch.
- Controls always accessible.
- Delicately calibrated.
- Sturdily constructed.
- Choice of several antenna pick-up systems.
- Tremendous gain.
- And countless other features.

**TOBE INTERFERENCE LOCATOR**

The climax of months of laboratory research. Now available for immediate delivery.

**\$255.00**



**A NEW RESISTOR**

Unexcelled in the New LOFTIN-WHITE

Direct-Coupled Circuits

Compare These Features:

- Hand-calibrated.
- Pigtailed end fits standard mounts also.
- Unchanging with age.
- Positive heat coefficient.
- Cadmium-plated tips.
- 2, 5 and 10-watt ratings.
- Priced at 50c. to \$1.25.

For meter multiplier work a specially calibrated resistor guaranteed accurate within ½ of 1% can be supplied at three times the standard list price. Order a sample quantity direct, if your jobber cannot supply you. Cash must accompany order.

**THE OFFICIAL HANDBOOK**  
of the TOBE Nation-wide Interference Campaign  
*Your Campaign!*  
25¢ Postpaid

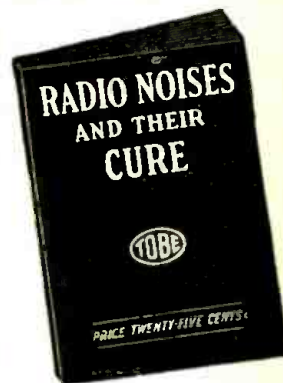

No Summer Slump With Auto Radio and TOBE Ignition Filterette Kits! Price, includes all necessary capacity and resistance

|                       |         |
|-----------------------|---------|
| 4-cylinder cars ..... | \$10.00 |
| 6-cylinder cars ..... | 12.00   |
| 8-cylinder cars ..... | 14.00   |

**TOBE DEUTSCHMANN CORP.**

PIONEER AND LEADER IN ELIMINATING RADIO INTERFERENCE OF EVERY DESCRIPTION

Canton - - Massachusetts

**RADIO — DEALERS SERVICE MEN**

DO YOU WANT TO RECEIVE "BIG MAIL?"

Sent from hundreds of radio manufacturers and others. Posting you on what's new in radio, catalogs, circulars, price lists, samples galore—mailed for a whole year.

Learn how by sending for complete information.

**NATIONAL RADIO TRADE DIRECTORY**  
*Addressing & Mailing*  *Printing & Multigraphing*

303 FOURTH AVENUE

NEW YORK CITY



# HOTEL MARYLAND

## CHICAGO

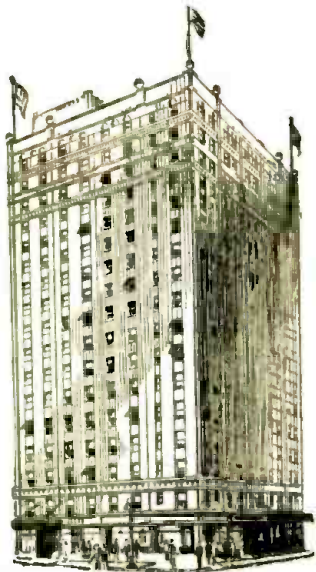

350 Rooms - - - All with Bath

RATES \$2.50 PER DAY AND UP

H. H. DECKER, *Manager*

900 Rush Street - - - On the Edge of the Loop

*In the heart of the "Gold Coast"*

# ALLERTON HOUSES

NEW YORK CITY, N. Y.

**S**O located they offer the social value of a distinctive address with the air and service of the select club; lounge, library, billiards, squash courts and hand-ball courts.

**\$15 to \$25 Weekly**

38th St., corner Madison Ave.

39th St., near Lexington Ave.

55th St., corner Madison Ave.

57th St., cor. Lexington Ave.

*for women only*

Chicago Cleveland

Allerton Houses, for Men and Women

## Automotive Radio

(Continued from page 639)

to the shield, which is, of course, grounded. The shield must be placed not less than an inch away from the spark plug, and this trouble will be eliminated.

The installer must always bear in mind that the electrical parts such as spark plugs and distributor points should be clean; for if they are dirty the problem of eliminating the noise increases tremendously. If the points and the spark plugs are properly cleaned the installer will find that eliminating the noise of the car is not a difficult task, which can be accomplished quite easily in a short time.

After the high-tension lead, there comes the low-tension system. The "brush noises" from the generator of the car are eliminated by placing a 2-mf. condenser across its terminals. The noise from this generator can be detected by a whirling noise in the speaker when the car is picking up speed. These condensers most always keep the noise from the low-tension system from bothering the listener. However, if this does not suffice in eliminating this noise, it may be necessary to by-pass the electrical instruments on the dashboard.

The installer will notice, when driving the car in various sections of a city, reception will vary from nothing at all to perfect reproduction. On the road, away from all structures, reception is sound and clear. It will be peculiar to notice that, in certain streets where there are tremendous buildings on both sides, the set will work beautifully; and yet there are places in the open where no reception is obtained. This is due to large buildings acting as reflectors rather than an absorber of the signal wave. Then, too, the particular open space where there is no reception may be one of those terrible "dead spots" which are an everlasting and unconquerable enemy to the radio fan. The listener will find, however, that reception, practically all of the time, is of the best; and there is no doubt of the fact that radio in a car is really a desirable thing and affords a great deal of pleasure to those who have a set installed in their car.

### DUPLEX TRANSMISSIONS

"**S**TEREOSCOPIC" broadcasting, once so much discussed, is being tried at Riga, in Latvia. Programs are picked up by separated microphones and broadcast, one on 524 and the other on 196 meters. The combination of the two is said to produce a more natural effect.

## Men Who Have Made Radio

(Continued from page 631)

improve the radio telephone which was still but a technician's plaything. Around him, fellow amateurs picked up his frequent transmissions—of phonograph records and voice—as amateurs today pick up television tests; not a finished program, but a delightful novelty. And the receiving amateur had then something that his lay friends could



listen to; not dots and dashes, but intelligible voice and music. Like the stone in the pool, of which every radio book tells us, Conrad's experiments had started a wave of popular interest in radio as a means of entertainment. The ranks of amateurs became augmented by "listeners." From outside the ranks of his little circle of coadjutors, there came the first "fan" letters. Twice a week that little program was broadcast for the first "invisible audience." The newspapers gave an occasional brief notice to the novelty.

The enthusiasm of Conrad communicated itself to his superiors; the vice-president of the Westinghouse Company, H. P. Davis, was induced to throw his influence in favor of a bold stroke. A transmitter was constructed in the East Pittsburgh works of Westinghouse, and hardly completed before Election Night in 1920. On this occasion the engineer, apprehensive of a failure, stood before his own little transmitter at home, ready to carry on if the new equipment should break down. But it didn't; the election returns were read out, into the ears of a thousand radio listeners.

What the "SOS" of the *Republic* was to marine radio, that election broadcast was to home radio reception. Everywhere in the United States, otherwise staid citizens acquired a new interest in life. They were busy winding coils and stringing wires; standing in queues, endeavoring to purchase a new contraption known as a "tube"; or probing a bit of reluctant mineral patiently with the end of a catwhisker. The public had discovered radio, with the sensations of Balboa stumbling into the Pacific ocean.

The new Pittsburgh station, shortly to become familiar to two hemispheres and several twilight zones as KDKA, was not to remain the world's only broadcaster for long. Other stations were built and equipped by the Westinghouse and other companies; even the navy undertook for a short time to give popular entertainment. In those days, not only the engineering side of radio, but the entertaining, was an amateur's job. The first ten years, undoubtedly, have been the hardest; but this is no place to tell the full story of the growth of Frank Conrad's idea.

While broadcasting, as it is today most familiar to the public, was becoming an institution, the ingenuity of the Pittsburgh enthusiast was going on to a possibility even greater. As an amateur, he knew the possibilities then being realized in short-wave operation. (You see, when the broadcast stations began to spread out on the dial, they speedily crowded the genuine amateur into the range below 200 meters; and the amateurs, thus driven to short waves, speedily proved the international range of those from 80 meters down.) While the commercial development of broadcasting was being carried on by others, Conrad was working away at a problem which is of still greater international importance. When KDKA with its long-wave broadcasts was talking to the American public, he sent out the same programs from short-wave transmitters to the world at large.

These short-wave programs were unsuspected by the "B. C. Ls." who had superseded the original amateur audience; but they were heard with rejoicing by lonely operators on far seas and remote islands, by exiles in tropical deserts and jungles; they

**ELECTRICITY OFFERS A BIG PAY**

**NOW YOU CAN LEARN AT HOME**

**HUNDREDS OF COOKE TRAINED MEN ARE MAKING \$60 to \$100 A WEEK**

**\$12 A Day**  
When I enrolled I was a laborer at small pay. Now I make \$12 a day in Electricity. Bob Korris, 213 S. Maple, Newkirk, Okla.

**\$65 A Day**  
But for your course I would still be on small pay. Instead of making as high as \$35 a day in Auto Electricity. Jacob Lentz, 1223 1st Av., Hillsboro, Oregon.

**LEARN BY DOING**

Why don't you get into Electricity, too? It's today's great Opportunity for you and every other man who is sick and tired of struggling along on small pay. Hundreds of "Cooke Trained Men" who were no smarter than you when they started now make \$3,000 to \$5,000 a year—and some make even more.

**LEARN AT HOME IN SPARE TIME**  
Learn with the famous L. L. COOKE "Work Sheet and Job Ticket" Method. It's simple, it's thorough, it's practical. It's just like actual shop experience, yet it's all done right in your own home with the Big Complete Outfit of Tools and Apparatus given to you without extra cost. And it's done in your spare time, without quitting your present job or losing a single hour's pay.

**PREVIOUS EXPERIENCE NOT NEEDED**  
You don't need previous experience—you don't need higher education to learn Electricity the L. L. COOKE Way. If you can read and write, that's enough. This great Training is amazingly clear and simple. There's nothing like it anywhere. It's the Training with hundreds of successful graduates; it's the Training that has put many men on Easy Street; it's the Training for you.

**GET STARTED—MAIL COUPON**  
"Cooke Trained Men" are the "Big Pay Men" everywhere. \$60 to \$100 a week is what many of them are making. That's the kind of a job for you. Get started under the famous L. L. COOKE Money Back Agreement. Act today to increase your pay. Send coupon for Big FREE Book, "Secrets of Success in Electricity." Mail coupon now.

**L. L. COOKE SCHOOL OF ELECTRICITY**  
Dept. 30-A 2150 Lawrence Ave., Chicago, Ill.

**FREE BOOK COUPON**

L. L. Cooke School of Electricity,  
Dept. 30-A, 2150 Lawrence Ave., Chicago, Ill.  
Send me entirely free and fully prepaid, your book "Secrets of Success in Electricity," with particulars about your Home Study Course in Electricity.

Name .....  
Address .....  
City ..... State .....  
Residents of Canada may send coupon to R. A. Farrow, Special Rep., 7 Medbury Lane, East Windsor, Ont., Canada.

*The Cooke Trained Man is the "Big Pay Man"*

**BE A RADIO DOCTOR**



Radio servicing offers the biggest opportunity for the man interested in radio. About 10,000,000 receivers need service some time or other, many are naturally inefficient and can be improved on. The Radio Doctors, Inc. is the only institution teaching exclusively radio repairs, having specialized on this phase of radio for a number of years.

**\$3,000 to \$5,000 per year**

The professional "Radio Doctor" receives \$2.00 or \$3.00 per visit and is welcomed in the best of homes—may I tell you more about this new, fascinating and extremely profitable business? Write now for free booklet, "Why the Radio Doctor." (Early inquiries will receive a blueprint of a recent well-known manufactured superheterodyne.)



E. W. PARKER, Pres. RADIO DOCTORS, INC., Dept. C11, 131 Essex Street, Salem, Mass.

**TO NEW READERS** Back issues of RADIO-CRAFT for reference needs can still be had at the regular price of twenty-five cents each. Send cash, check or money order to RADIO-CRAFT, 98 Park Place, New York, N. Y.



penetrated even into the polar night. It became known first to those men who go into strange and mysterious places, that there is a radio link binding them to their home countries.

The results of those short-wave broadcasts are at last becoming known to the general public, just as did the first transmissions of KDKA ten years ago. They have as by-products the trans-oceanic telephone; the international relay broadcasts, whereby five continents may hear the words spoken in a single room. Today, the public is becoming short-wave conscious, and thereby internationally-minded; as country after country becomes a speaking voice, instead of an overlooked area on the map. Nation after nation is adding to the number of short-wave broadcasters; since in the static-ridden tropics, or among the widely-scattered inhabitants of such great regions as Central Africa and Northern Asia, only a short-wave station can cover the needed area. Perhaps the short-wave audience will entirely supersede the present groups of radio listeners. In any event, we may check against Frank Conrad's radio hobby the second great success.

We have yet a little while to wait for the accomplishment of the third. The illustration at the head of this article shows Dr. Conrad (the self-educated boy has had the richly-earned robes of a doctor of science laid on his shoulders by the university of his city) standing beside the projector head of the television transmitter of W8XK (KDKA)

which is repeating moving picture images to the scattered, select group of amateurs who are working to anticipate universal television broadcasts; just as their predecessors of ten years ago formed his first little broadcast audience. It is only the short-wave broadcaster which can make television in the theatre and the home practical; if we have to wait till 1940 for this, it will be a fitting climax to half a century of Conrad's inventive activity and enthusiastic labors for electrical progress.

### A Short-Wave Receiver

(Continued from page 641)

On the orange coils, I get PH1, 16.88 meters, at about 90 1/2 on the dial. This station comes in at 59 1/2 on the red; on these coils W2XK, 17.36 meters, is at 64 and W2XAD, 19.46 meters, at 92. The yellow coils give W2XAD at 34 on the dial, W8XK, 25.4 meters, at about 79, G5SW (25.53) at about 83; and CJRX (25.60) at 86. On the green coil W8XK is at about 15; G5SW at 21; CJRX, 26; VK2ME (28.50 meters) at 46; W2XAF (31.4) at 64; and above that several transatlantic phone stations. All these come in with good volume when conditions are not too bad. PH1 was splendid the morning this was written.

#### List of Parts Used

Three Pilot .00014-mf., 7-plate variable condensers (C2, C3, C6);  
One Pilot .0003-mf., 15-plate variable condenser (C12);

## NEW BISMARCK HOTEL

### Randolph at La Salle

A modern hotel where the hospitality of yesterday is enhanced by the cheering luxuries of today.

Light, airy rooms—beautifully furnished and providing home-like comfort.

Famous for good food.

Rooms \$2.50 up—  
with Bath \$3.50 up.

Write for Booklet A-4 with city map.

## CHICAGO

**DO YOU WANT TO STOP TOBACCO?**



Banish the craving for tobacco as thousands have. Make yourself free and happy with Tobacco Redeemer. Not a substitute, not habit forming. Write for free booklet telling of injurious effect of tobacco and dependable, easy way to relieve the craving many men have.

**FREE BOOK**  
Newell Pharmacal Co.  
Dept. 928 Clayton, Mo.

EVERY  
SERVICE MAN  
SHOULD OWN  
THIS BOOK!

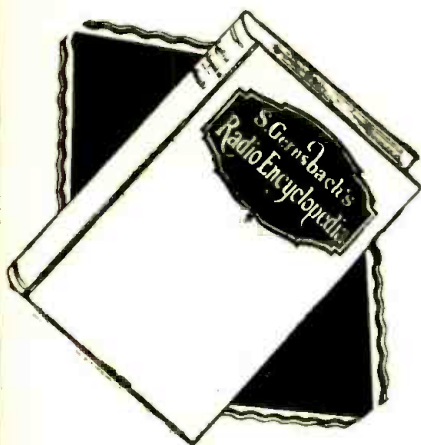

(1930 Definitions)  
**FULLY ILLUSTRATED**  
Size 9 x 12 in.  
Over One Inch Thick  
168 Pages  
Written in Plain English

## S. GERNSBACK'S RADIO ENCYCLOPEDIA

The First Real Radio Encyclopedia Ever Published

Regular Price **\$2.00**      Our Special Price **\$1.49**

**E**DITED by SIDNEY GERNSBACK, Author of "Wireless Course in Twenty Lessons" — "One Thousand and One Formulas" — "Practical Electricity Course" — "The Radio Educator," etc.

S. GERNSBACK'S RADIO ENCYCLOPEDIA is the only standard work ever published in America attempting to classify alphabetically the countless words used in the highly specialized science of RADIO. The ENCYCLOPEDIA is written in plain English so that everybody can understand the definitions and descriptions.

No expense has been spared, covering over two years in compilation, to make it worthy a place in your library.

It is published in one volume—168 pages—size 9 x 12 inches, over an inch thick and nicely accommodates the beautiful illustrations and the large, easy-to-read type.

The work contains 549 photographs, drawings and diagrams.

**REMEMBER THIS IS A REAL ENCYCLOPEDIA — NOT A DICTIONARY** — and very few of the things described and illustrated in this volume can be found in any diction-

ary, or any other encyclopedia.

The book contains as a supplement a classified cross index designed to bring together radio references under one heading having relations in common.

All circuits new and old are described by word and picture and every part and apparatus used in Radio is explained and made understandable by means of photographs and drawings.

The volume is printed upon fine paper—bound in full black Keratol, marbled paper fly leaves and end sheets, with the title stamped in gold.

### SEND NO MONEY

Just Pay Postman  
(Canada or Foreign send Check or Money Order for \$1.75)

ISKOR PRESS, Inc., R-6-30  
286 Fifth Avenue,  
New York, N. Y.

Send me one copy of Sidney Gernsback's First Radio Encyclopedia in one volume as advertised. I will pay postman \$1.49 plus postage on delivery.

Address .....  
Town and State.....  
Name .....



One Cardwell .00015-mf., 5-plate variable condenser, Type 167E (C9);  
 Five Karas vernier dials;  
 Three Buffalo 4-prong tube sockets, and tube bases for home-made plug-in coils, (L1, L2, L3);  
 Three type '22 screen-grid tubes, and three Benjamin No. 9040 sockets (V1, V2, V3);  
 One "TINYTOBE" .0001-mf. fixed condenser (C1);  
 Twelve Pilot "Isograd" .01-mf. fixed condensers (C10, and C13 to C23 inclusive);  
 Two Dubilier small mica .00025-mf. fixed condensers (C24, C25);  
 One Dubilier 1-mf. fixed condenser, type 907 (C26);  
 Two Dubilier .02-mf. fixed condensers, (C5, C8);  
 Two Sangamo .00015-mf. fixed condensers, (C4, C7);  
 Four Aero R.F. chokes, No. 60 (RFC 1 to 4);  
 One Silver-Marshall R.F. choke, No. 227 (RFC5);  
 One X-L grid condenser No. G-5 (C11) and One Tohe 10-megohm grid leak, "Tipon" type (R3);  
 Two Aerovox 100,000-ohm fixed resistors (R1, R2);  
 Three Eveready cells, No. 950, for grid biasing ("C" 1½v);  
 One '12A type tube, and Benjamin No. 9040 socket (V4);  
 One Aero short-wave coil base for two windings (L4, L5) or  
 General Radio plugs and jacks for home-made coils and bases.  
 One Carter "Midget" 10-ohm rheostat (R4);  
 One Yaxley "Junior" 20-ohm rheostat (R5);  
 One Carter short jack (J); and  
 Miscellaneous material, as described in text.

## Tuning for Foreign S. W. Stations

(Continued from page 643)

one every ten kilocycles from 550 to 1,500 kc., inclusive. This gives one channel to a division on our dial, and each station therefore corresponds to a different reading.

It is not necessary to discuss the relation of kilocycles to meters here (see Fig. 2) except to say that the frequency increases more and more rapidly as the wavelength becomes shorter. Between 15 and 80 meters (the effective short-wave broadcast band) there is more than sixteen thousand kilocycles separation, or sixteen times the width of the upper broadcast band. The average short-wave set covers this with three or perhaps four coils and as many revolutions of the tuning dial—from 0 to 100. If stations were operated on channels ten kilocycles wide, as in ordinary broadcasting, we would cover three to four hundred of them in one turn of the dial. On the smaller coils, the number is even greater. The station, therefore, covers only a small part of the space between two numbers on the dial. If we skim over the dials in the manner to which we are accustomed in medium-wave tuning, we will pass over many "noises" in our set which are really stations that would give good loud-speaker strength if properly tuned-in.

The proper procedure, therefore, in operating a short-wave set, is to calibrate the

radio engineers do not guess—

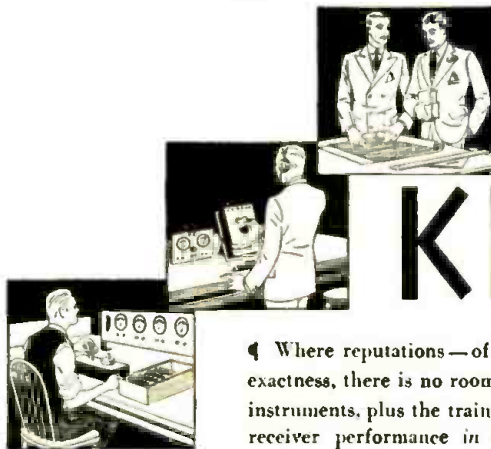

# THEY KNOW

Where reputations—of both products and men—depend on exactness, there is no room for guesswork. Modern measuring instruments, plus the trained scientific mind, determine radio receiver performance in advance. The certainty of this performance is guaranteed by the use of tested and

proven parts. Polymet Products have been approved by the engineering laboratories of practically all leading receiver manufacturers. Over 80% of them use Polymet Products in their production — — —

which is possibly the best proof that "Polymet Engineers do not guess;—they know, too!"

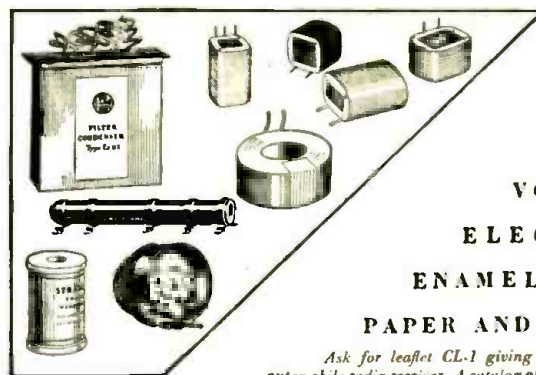

RESISTORS  
 TRANSFORMERS  
 VOLUME CONTROLS  
 ELECTRICAL COILS  
 ENAMELED MAGNET WIRE  
 PAPER AND MICA CONDENSERS

Ask for leaflet CL-1 giving diagrams of popular circuits including automobile radio receiver. A catalog of Polymet parts is available on application.

POLYMET MANUFACTURING CORP. 831-A East 134th St., New York City

# Polymet Products



## "VOICE OF THE ROAD"

A 1930 AUTOMOBILE DEVELOPMENT—Remotely Controlled

Here is a finished product that really works. Finished in design to the last requirement for universal adaptability to the automobile.

Here are some of the features incorporated in this advancement:

- |                           |                                 |  |
|---------------------------|---------------------------------|--|
| 1. Remote Control         | 5. 3 Stages of Screen-Grid R.F. | 9. Adaptable To Any Type of Antenna        |
| 2. Single Dial Control    | 6. Power Detector               | 10. Least But Not Last, "Within the Price" |
| 3. Compact                | 7. Screen-Grid Audio            |  |
| 4. Installed in Two Hours | 8. Shielded Battery Cables      |  |

**JOBBERS - DEALERS:** The automobile market is wide open. Here is your chance to act as our agent and share in the profits of which will be realized in this new development. Send coupon below for further information of our special proposition.

----- SEND TODAY -----  
**CONTINENTAL WIRELESS SUPPLY CORP.**  
 60 Newark Street, Hoboken, N. J.

- Kindly send me your special agent's proposition.
- Kindly send me further particulars on your auto kit.

Name..... Address.....  
 City..... State.....





**STERLING HOTEL**

**Atlantic City**  
**NEW JERSEY**  
**COMFORT**  
*Without Extravagance*

Beach Front Service at Moderate Prices. Service, cuisine and appointments equal to that offered at the best beach-front hotels.

**Fireproof**  
**All Outside Rooms**  
With or Without Private Baths  
Phone in All Rooms — Garage

**The Norris Co.,**  
**FRED M. ALLGAIER, Mgr.**  
**KENTUCKY AVE**  
*near BEACH*



**QUIT TOBACCO**



No man or woman can escape the harmful effects of tobacco. Don't try to banish unaided the hold tobacco has upon you. Join the thousands of inveterate tobacco users that have found it easy to quit with the aid of the Keeley Treatment.

**KEELEY** Treatment For Tobacco Habit Successful For Over 50 Years

Quickly banishes all craving for tobacco. Write today for Free Book telling how to quickly Free yourself from the tobacco habit and our Money Back Guarantee.

**THE KEELEY INSTITUTE**  
Dept. L-702 Dwight, Illinois

**I CHALLENGE**

you that I will teach you, by mail, in one lesson, the simplest, shortest method all for \$1.00. Not telepathy. You can read one's mind to a dot, by only looking in the eyes of partner, chum, sweetheart, etc. Praised by New York, Boston, Montreal Police Chiefs; colleges; Thurston, Blackstone, etc. If fake, let them arrest me.

A. HONIGMAN, Dept. WS-5, Sta. E., P. O. B. 85, Montreal, Canada

receiver in the method illustrated, and make notations where certain desired stations should fall on the dials. Note when these stations may be expected to operate; and time for them at the proper times, on the proper dial readings. Pick up the signals by the "beat-note" method; that is, set the detector tube oscillating, and pick up the carrier-wave or "squeal." After the carrier is found, keep the wavelength or tuning dial set in the exact center of the squeal; and turn the regeneration dial back past the point of oscillation. Then, very slowly, move it up again until the best reception is obtained.

The third point is, how shall we determine what stations to tune for? At the present time, all short-wave broadcast stations are of an experimental nature, and their wavelengths, as well as schedules, are subject to sudden changes without notice. And, since distance means little or nothing in short-wave reception, the carrier-wave in its longer path is more subject to atmospheric conditions than the nearby medium-wave broadcasts. Stations which can be heard with great volume at one season of the year are often unheard at another, regardless of the power which they use. The short waves, also, are peculiarly affected by sunlight; some being reduced in strength, and others greatly increased in volume on the arrival of darkness.

Since reception is world-wide, means of communication are slow, and no universal language is yet in use, no accurate list of stations can be compiled. (It may be said that many of the most powerful stations refuse to give any information for publication, as to their activities.—Editor.) For that reason, short-wave fans have grown to depend on each other to keep posted on the various changes which are taking place. The writer, realizing this, has formed an organization of active short-wave experimenters to gather and exchange the most recent information on short-wave broadcast operation. By this means, timely bulletins are available to members, and new stations are being daily discovered which appear on no list.

In conclusion, it may be said that reception of short-wave broadcasts directly from overseas is not so difficult as may be imagined; it is a commonplace occurrence to-day. In the words of the well-known announcer of PCJ: "It is no longer unusual to hear programs emanating from half-way around the globe." It is possible to pick up programs in Siamese, Russian, German, Spanish, French and many other languages, in addition to English, to-day.

Now is the time for every radio fan of an enquiring turn of mind to start in this fascinating game; for it is becoming more and more commercialized every day, and the stage of thrills will soon be passed. As it is, the larger stations no longer welcome reports of reception, regardless of the distance covered.

There is, however, much room for experiment on short waves, and who knows what developments are forthcoming in this vast unexplored field? International rebroadcasts, conversations from ships at sea, airplanes in flight talking to land stations, television, and many other novelties await the short-wave fan to-day; and the era of short-wave work has only begun.



**The MADISON**

ILLINOIS AVENUE  
Overlooking Boardwalk and Ocean

**"A Hotel Distinctively Different"**

JUST COMPLETED IN  
**Atlantic City**

Unexcelled Colonial Hospitality

**Now Ready for YOU**

Fireproof — Showers and Baths Throughout

From \$4.00 daily  
European Plan

From \$7.00 daily  
American Plan

**FETTER & HOLLINGER, INC.**  
Eugene C. Fetter  
Managing Director

**ELECTRIFY YOUR RADIO FOR ONLY \$6.85 COMPLETE**

Why discard your present good set when you can electrify it for only \$6.85, and banish the annoyance and expense of buying new "B" batteries?

**Over 100,000 Townsend "B" Power Units In Use**

Hooked up in a few minutes. Use same tubes—no changes. You'll be amazed at the improvement in reception and distance getting. Send name and address today for full details, proof and Free Trial Offer.

**TOWNSEND LABORATORIES**  
723 Townsend Street Chicago, Illinois



**HOTEL EMBASSY**

**BROADWAY AT 70<sup>TH</sup> ST. NEW YORK**

**400 LARGE LIGHT ROOMS ALL WITH BATH**

**\$2.50 A DAY FOR ONE PERSON**  
**\$3.50 A DAY AND UP FOR TWO**

*Special Rates for Permanent Guests*

**FINE RESTAURANT REASONABLE PRICES**  
Club Breakfast, 30¢ to 50¢  
Luncheon, 75¢  
Table d'Hote Dinner, \$1.00

**EDMUND P. MOLONY**  
Manager



# Practical Sound Projection Maintenance

(Continued from page 645)

tone needle instead of the full-tone, you may be free from this trouble. A half-tone or low-tone needle will frequently remain in the proper groove while the full-tone will jump.

If the needle does jump or single-track, and you are willing to spend the time and patience to master the trick, you can restore it to synchronization. Turn off the horns in the theater, letting the picture run and leaving only your monitor on. Place your arm on a convenient and steady rest and, after determining whether the sound is ahead of or behind the picture, lift the pick-up slightly and place it either ahead or behind the groove in which it has been traveling. If the record is single-tracking, place your hand on the pick-up and press down. This will in many cases "cut-through," and you will have no trouble with that record thereafter. Of course, after you have cut through, you will still have to restore "sync" by the method outlined above. This may sound very hard to do—practically impossible—but, if you are willing to spend a little time, you will be surprised by the ease with which you can accomplish the trick, to the admiration of anyone who may watch you.

## Sound on Film

The greatest enemies of sound on film are dirt, oil and vibration. Dirt and oil on the film, in the optical system, on the photoelectric cell, or in fact in any place in the booth where it can be transmitted to the above named parts, is highly undesirable. A drop of oil on the required parts at regular intervals is always superior to a deluge of oil when the spirit so moves you. Careful oiling regularly and cleanliness not only of your machines but your entire booth will do much toward saving you trouble in many ways. Light can not penetrate oil and dirt as successfully as it does clean film, clean lenses, clean exciter lamps, and photoelectric cells. Take the hint; you will never regret it.

Watch your exciter lamp and see that it is not turning brown, or the filament sagging or showing other signs of old age. Keep it in perfect alignment; do not take for granted that, because you once lined it perfectly, it will stay that way. Check it frequently and keep it lined.

Watch your photoelectric cell; be sure that it is clean and is making positive contact. Be sure that no extraneous light is getting into the cell window. The light from the exciter lamp, as varied by the film, is the only light that is meant to enter the cell; any other light entering the cell at the same time will spoil the quality or introduce foreign noise which is not desirable.

Check your lens assembly frequently, seeing that the lenses are perfectly clean; and be sure the assembly is focused correctly, for this has much to do with good quality.

Keep the sprockets in the sound-head absolutely clean; for dirt or built-up emulsion will tend to cause the sprocket to pull the film unevenly and make the sound "wobble." Be sure your film guides are adjusted so that the sound aperture is in the center of the sound track (as shown in

Fig. 1). If the sprocket holes pass by this aperture or other unevenness (other than the track itself) all sorts and kinds of noises will be made.

Any attention or time that you can give to either your machines or yourself will pay good dividends; for the well-kept machines and the competent projectionist are both factors which are more than appreciated in the industry to-day, by the producers, the exhibitors, and right on down to the very people who say "Hello" to your box office before they come into your theater.

## The Cooperative Laboratory

(Continued from page 647)

the casual reader to assume that these were the final iron-bound specifications. The circuit is still very much in the experimental stage.) R2 should be about 100,000 ohms, while R3 should be about 6,000 ohms. The resistance R4 should be variable, if possible, and should be around 400 ohms. A standard 400-ohm potentiometer has worked out very well in this position.

In concluding this article, it should be emphasized that the use of your present detector, in connection with the additional installation of the direct-coupled amplifier, will avoid several pitfalls which have proved real stumbling blocks for many experimenters. You will then encounter no trouble with unbalancing of tuning condensers. The stability of your R.F. amplifying circuit will not be affected in the least, and the biases on your direct-coupled audio amplifier will not "drift" when you tune to a strong carrier wave.

Next month we will reveal the details of a push-pull resistance-coupled amplifier which is capable of delivering good audio quality without choking, and which operates from the standard-voltage power pack.

## New Radio Devices

(Continued from page 637)

blade to release the screwdriver lock. The knife blade is sturdy and will meet the exacting conditions of service work.

Steel of a high quality is used for both the blades and, with reasonable care, the knife will render service for years.

A "sheep-foot" knife-blade is shown in the illustration; but a "pear-shape" blade is also available, although it is not so highly recommended for regular service work. A cocobolo handle is used on this knife; and its nameplate may be marked for identification. When opened, it is 6½ inches long over all.

## Aluminum Box Shields

Beautiful silver dip finish, 5 x 9 x 6 inches, \$1.89. We make any size to order in 24 hours. No. 1424 Federal Anti-Cap Switches, \$1.95. Genuine Baldwin Type "C" Phones, a necessity for short-wave reception, \$3.65 a pair. Test Prods, hard rubber handles, 59c.

BLAN THE RADIO MAN, Inc.  
89H CORTLAND ST. - - NEW YORK

# Open this FREE BOOK



## and you open the door to SUCCESS IN RADIO

YOU, too, can be trained for a big-time radio job . . . Clip this coupon now and send for this FREE BOOK . . . Read it page by page . . . see for yourself why thousands of fellows just like you are now making from \$50 to \$100 a week . . . This free book gives you 40 fascinating pages of pictures and text, all about RCA Institutes, the only school that is endorsed by the Radio Corporation of America . . . The school that actually sends you radio instruction direct from RCA . . . the very source of radio achievement!

### Easy to Learn Radio at Home in Your Spare Time

Let the RCA Institutes Home Laboratory Training Course give you the real inside facts of radio . . . quickly and easily. Use your spare time to train for success with the remarkable outlay of screen-grid apparatus given to every student of this course. You learn how to solve every radio problem such as installing, repairing and servicing fine sets. This is the training that will help you to make money in radio!

### RCA Graduates in Big Money

For more than 20 years, there has been a well-paid position in Radio waiting for practically every graduate of RCA Institutes. This is a record unequalled by any other school. Only the vast resources of RCA could give you this practical training . . .

### Send for this Free RCA Book

"Radio . . . the Field of Unlimited Opportunity."

Start today on the road to Success in Radio . . . Send for this FREE BOOK. Every page is packed with pictures and text telling you all you want to know about RCA Institutes, the oldest and foremost Radio training organization in the world. Radio can easily be YOUR ROAD TO SUCCESS . . . That's why you should CLIP THIS COUPON NOW!

## RCA INSTITUTES, INC.

A Division of Radio Corporation of America

RCA INSTITUTES, Inc.  
Dept. SRA-6, 75 Varick Street, New York

Gentlemen: Please send me your FREE 40-page book which illustrates the brilliant opportunities in Radio and describes your laboratory-method of instruction at home!

Name-----

Address-----



## When Your Tubes Have Three Lives

Like the proverbial cat, your tubes can have several lives. It's just a question of treatment. If your A.C. tubes last less than six months, you are throwing away six to twelve months of full normal life. Charge it to EXCESSIVE line voltage.

If your set sours early in the evening, when folks turn on lights and radios, blame it on LOW line voltage.

In either event, it now becomes your fault. Because, by investing the small sum of \$1.75, you can overcome the effects of high and low line voltages forever. Here's how:

### Automatic Line Voltage Regulator Clarostat

Its name tells the story. Compensates for all line voltage fluctuations. Applied to attachment plug of usual A.C. set—no tools, fussing, experience. AUTOMATIC—provides immediate change in compensating resistance for all voltages. No taps, switches, worry. Neat. Compact. DIFFERENT.

Install it—forget it—and save the price of two or three sets of A.C. tubes per year—and perhaps a costly power pack failure.

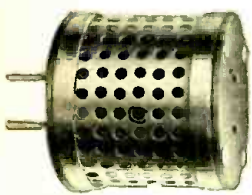

ASK your dealer to show you the greatest investment in radio today—the AUTOMATIC Line Voltage Regulator Clarostat. But beware of substitutes! Watch out for switching! Demand what you ask for.

CLAROSTAT MFG. CO., INC.

Specialists in Aids to Better Radio

285-7 N. 6th St. :: Brooklyn, N. Y.

*Be An Amperite for every tube.*  
*Dr. Radio Engineer*

### The Prescription for Better Radio Reception

AMPERITE automatically maintains the most efficient tube voltage. Improvement, sensitivity, volume. For every tube. \$1.10 with mounting (in U.S.A.). At all dealers.

AMPERITE Corporation  
661 BROADWAY, NEW YORK

FREE—"Amperite Tube Chart." Write Dept. RC-6

**AMPERITE**  
The SELF-ADJUSTING Rheostat

This symbol in a radio diagram means—

## Review of Recent Radio Literature

TELEVISION, by H. Horton Sheldon, Ph.D. (chairman of the department of physics, Washington Square College, New York University; science editor, New York *Herald Tribune*) and Edgar Norman Grisewood, M.A. (instructor of physics, New York University). 190 pages, illustrated. 5½ by 8¾ inches. Stiff buckram binding. Published by D. Van Nostrand Co., New York. Price, \$2.75.

In spite of the large mass of material that has accumulated through the efforts of many workers in the field of television, it is surprising how much has been condensed into this book in such a clear and concise manner that the layman can grasp it. And this does not reduce its value to the expert; for references are fully given in all instances where the subject becomes too technical to be included in a book of this scope. In fact, it is safe to say that the entire art is included in this book with its references; it should be read by all who are interested in any phase of radio. It is written by men who know physics, to cover a subject which combines many branches of physics, and is the first comprehensive American book on television.

Chapter 1 clearly outlines the essentials of television; Chapter 2 covers briefly the historical background and shows the development of television from the early methods of transmitting still pictures.

Optical science, which plays an important part in this subject, is covered in an elementary way in Chapter 3, which also tells much of importance about the human eye. While the nature of light cannot be mathematically considered in a book of this type, it is sufficiently covered in Chapter 4 to give the reader a general idea of its basic principles.

The selenium cell, the first light-sensitive device discovered, has always played an important role in picture transmission, and is fully described in Chapter 5. Its new sister, however—the photoelectric cell—who is more active, alert, and quicker makes television possible and is explained in Chapter 6.

Chapter 7 tells all about the glow-lamps (mainly neon lamps) which are used at the receiving end to produce the moving picture or image; and Chapter 8 about oscillographs, both electro-mechanical and the cathode-ray types. The latter may play an important part in television in the future, due to its virtually instantaneous action.

Chapter 9 shows the different methods of scanning an image and Chapter 10 those of synchronising the scanning devices at the transmitter and receiver.

Telephotography, or the art of transmitting photographs by wire or radio, now commercially successful, is the forerunner of television and forms the subject of Chapter 11.

Then we start with television itself in its present forms, and find described in detail the Baird Teletvisor (Chapter 12); the Bell system (Chapter 13, which occupies more space in the book); the Jenkins system (Chapter 14); and the Alexanderson System (Chapter 15). These are the four main systems in present use and, while basically alike, they vary greatly in detail.

Chapter 16 shows some interesting relays; Chapter 17, amateur equipment, and the book ends with Chapter 18, which treats of the future of television. (C. J. F.)

WIRELESS PICTURES AND TELEVISION, by T. Thorne Baker (Fellow of the Institute of Physics; Associate Member, I.E.E.; Member, I.R.E.; Fellow of the Physical Society of London; Fellow of the Royal Photographic Society). 184 pages. Illustrated. 5 by 7½ inches. Stiff buckram binding. Published by D. Van Nostrand Co., Inc., New York. Price, \$2.50.

The art of transmitting pictures by electricity dates back to 1837 when Morse, the inventor of the telegraph, succeeded in recording code messages

electrically on a paper tape at the receiving end. From that time until the publication of this book Mr. Baker carries us through the evolutionary stages of picture transmission and television. The main bulk of the book deals with the transmission of still pictures, the last chapter only covering television; but since the two are as closely related to each other as "wireless" is to "radio," we believe it should be included in the libraries of all television and radio experimenters. The book covers the theory very completely and gives references to other papers whence material has been taken. While it goes into higher mathematics where this is deemed necessary, the general style is such that the layman can understand it.

Chapter 1 tells us about the earliest forms of recorders as used in the telegraph and for transmitting images. Chemical recorders as well as the code method of transmitting "picture information" are described.

Some very good information about selenium cells and photo-electric cells is given in Chapter 2.

Chapter 3 shows various forms of receiving instruments for still pictures. Galvanometers and oscillographs, including the cathode-ray type, are described in this chapter, and mechanical inkers for drawing the picture are included.

Chapter 4 deals with the photographic image and photography, and Chapter 5 with synchronising devices, such as tuning forks and phonic motors. Relays, illuminants, and batteries are also covered in this chapter.

The transmission of photographs with selenium cells is described in Chapter 6, as well as the first commercial apparatus.

The telautograph, a machine for telegraphing sketches, drawings, autographs, handwriting, etc., is fully described in Chapter 7.

The relief system of sending pictures fills Chapter 8. Both Belin's Telestereograph and Tschornor's process are described in detail.

Chapter 9 covers the half-tone method of transmitting pictures and Chapter 10, the Bell Telephone System, which divides the picture into lines. Natural color transmission is also described.

So far the book has described only the transmission of photographs over wires. In Chapter 11, radio transmission with its accompanying problems is considered. This brings us to the television field, which is covered in Chapter 12, though rather briefly, as the greatest strides in television have been made since the first publication of the book. However, color transmission, the Campbell-Swinton method which employs the cathode-ray oscillograph, and the Baird system are described in this chapter. (C. J. F.)

TELEVISION, by Alfred Dinsdale (Asso. I.R.E., editor *Television Magazine*), with a foreword by Dr. (now Sir) J. A. Fleming, M.A., D.Sc., F.R.S. 180 pages. Illustrated. 5 by 7½ inches. Stiff buckram binding. Published by Television Press, London. Price, 5/6 (\$1.38).

The foreword, as a notable scientist's viewpoint of the subject, is worth anyone's time to read; it familiarizes us with the importance that television will play in the future.

Chapter 1, the introduction, merely inspires enthusiasm about the subject, and Chapter 2 starts in with the heart of television, the electric eye, showing the action of the human eye, and briefly outlining the earliest experiments. The next eight chapters cover the history of the development of television and the various systems employed.

The final chapters, 11 to 15 inclusive, are of interest to all experimenters; for they cover many interesting possibilities of television. The theory of the subject is discussed, showing the speed limitations inherent in present methods, "Phonovision," or the recording of picture-sounds on a phonograph record is described; also "noctovision," which employs infra-red light and makes possible "seeing in the dark." John L. Baird's transatlantic experiments are described, also his methods of stereoscopic and television in natural colors. Although the main bulk and interest of the book is devoted to Baird's achievements, this does not detract from its value and we may fully recommend it to all readers. (C. J. F.)





# BRAND NEW CORONA GENUINE Model #3

*Lowest Price—Easiest Terms  
Ever Offered*

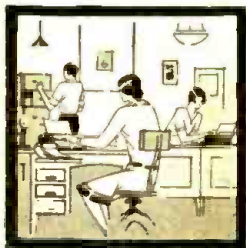

**H**ERE'S your chance to own that *brand new* Genuine Model 3 Corona you've wanted—on the easiest terms ever offered—at the **LOWEST PRICE** ever offered. Complete in every detail; back spacer, etc. *Manufacturer's Guarantee.* Recognized the world over as the **FINEST, STRONGEST, STURDIEST PORTABLE BUILT.**

S. Joveton writes: "It truly is a wonderful machine. I am very pleased with it and find it very simple to work although it is the first typewriter I have ever used."  
Don P. Fina, composer and pianist says: "Corona has helped me put my songs over and is still doing it. I find it just the thing for writing words to songs and for all correspondence to the profession."

F. J. Barsuglia, Jr. writes: "I am very well pleased with your little Corona and I must say I do not know what I would really do without it. It works like a charm and has every convenience of a larger machine."  
Mrs. G. Bernstein says: "Allow me to thank you for prompt delivery of the Corona. I am delighted with it and know I shall derive great pleasure from its possession."

## *Yours for 10 DAYS FREE*

Only a limited number of these splendid machines available. To get one, you must act now! Experience the joy this personal writing portable typewriter can give you! Use it ten days free! See how easy it is to run and the splendidly typed letters it turns out. Ideal for the office, desk, home, traveling. Small, compact, light, convenient. Don't send out letters, manuscripts, reports, bills in poor handwriting when you can have this Corona at such a low price on such easy terms. Remember, these are *brand new* machines right out of the Corona factory.

**Carrying Case FREE**  
**If you act NOW!**

Leatheroid carrying case, oiler, instructions free on this offer. Send no money—just the coupon. Without delay or red tape we will send you the Corona. Try it 10 days. If you decide to keep it, send us only \$2—then \$3 a month until our special price of \$39.90 is paid. Now is the time to buy. This offer may never be repeated.

**Save Money—Use This Coupon**

Smith Typewriter Sales Corp.  
(Corona Division)  
469 E. Ohio St., Chicago, Dept. 1136.

Ship me the Corona, F. O. B. Chicago. On arrival I'll deposit \$2 with express agent. If I keep machine I'll send you \$3 a month until the \$37.90 balance of \$39.90 price is paid, the title to remain with you until then. I am to have 10 days to try the typewriter. If I decide not to keep it, I will repack and return to express agent who will return my \$2. You are to give your standard guarantee.

Name .....

Address .....

Employed by .....



# PATENTS

## Protect Your Ideas

*Write for Instructions, free on request - - or send drawing or model for preliminary examination of Patent Office records*

**Promptness Assured with Best Results**

# Miller & Miller

PATENT ATTORNEYS

*Former Members Examining Corps, U. S. Patent Office*

265 MCGILL Building, Washington, D. C.



# PATENTS TRADE-MARKS

**DO NOT LOSE YOUR RIGHTS TO PATENT PROTECTION**

*Before disclosing your invention to anyone send for blank form "EVIDENCE OF CONCEPTION" to be signed and witnessed.*

**LANCASTER, ALLWINE & ROMMEL**  
(Registered Patent Attorneys)  
475 Duray Bldg., Washington, D. C.  
Originators of forms "Evidence of Conception"



# PATENTS

**TRADEMARKS - COPYRIGHTS**

*Before showing your idea to anyone, send for new "Duplicating Invention Record" - you keep a copy for evidence and send me a copy for advice and exact cost of patent. Prompt Personal Service. Advice and Record free on Request.*

**JOHN J. LYNCH, Registered Patent Attorney**  
41-F Park Row, International Building,  
New York City Washington, D. C.

# PATENTS

*Write for Free Guide Book, "HOW TO OBTAIN A PATENT" and Record of Invention Blank. Send model or sketch and description of your invention for our Free Opinion whether it comes within Patent Office Rules. RADIO and ELECTRICAL Cases a Specialty. Prompt Efficient Service. PAYMENT OF FEES IN INSTALLMENTS*

**VICTOR J. EVANS & CO., 923 - 9th, Washington, D. C.**

# FREE! RADIO BARGAIN CATALOG

## ALSO FREE RADIO GIFT



*Send now for this new free radio catalog which saves you many dollars on radio outfits, kits, parts, tubes and accessories! Also TIME CONVERSION CHART FREE. Tells you instantly what time it is in any part of the world. Given free if your request for catalog reaches us this month.*

# 20th CENTURY MAIL ORDER CORP.

202 JACKSON ST., CHICAGO, ILL.

**Genuine PILOT Products**

**SUPPLEMENTARY DIAGRAM—PACKAGE No. 1.** Published by Radio Treatise Co., New York. 115 sheets, 8½ by 11 inches, punched for standard filing, each illustrated. Price, \$2.50.

As a supplemental reference the publishers have prepared this diagram package which includes the wiring diagrams of the late receivers of foremost radio manufacturers, but does not duplicate the circuits in the "Trouble Shooter's Manual" by John F. Rider.

In the list are represented Steinie, All-American (Mohawk), Gulbransen, Bremer-Tully, Earl, Fada, Philco, Peerless, Temple, Brunswick, Amrad, Spar-ton, Audiola, Balkite, Sonora, Crosley, Kennedy, Stewart-Warner, Automatic Electric, Radiola, Majestic, Stromberg-Carlson, Edison, Bosch, Victor, Grebe, Traveler, Silver-Marshall and Eveready.

Only one side of each sheet is used. Wherever available electrical values have been shown on the diagrams, which are black-on-white. In addition to circuit wiring, the parts layouts and instrument details of certain sets are also shown.

Electrostatic speaker models, screen-grid models, automatic control models, D.C. and A.C. models, 25, 50 and 60 cycle models, battery and De Luxe A.C. models, automatic-tuning models, and classes of all kinds are included in the contents; which are not sold as separate sheets.

### RADIO NOISES AND THEIR CURE.

Published by the Tobe Deutschmann Corporation, Canton, Mass. 72 pages, illustrated, 6 by 8¾ inches. Price, 25 cents.

This little book is already in a second and enlarged edition, indicating the interest which its theme, "The Radio Interference Problem and Its Solution," have for the radio trade and the great radio audience. Its publishers, who have been the originators of an incessant campaign against man-made static, have organized an interference engineering service, for dealing with conditions in any given community where public interest has been aroused to the extent of asking a survey. The book may be read by the layman for its educational value in explaining the cause and cure of electrical noises; and it is especially designed for the electrician and the Service Man, in explaining the methods of locating interference caused by apparatus, whether defective or not, and curing it. All recommendations are practical; though specifications for remedies are in the type numbers of the publisher's extensive line of radio-frequency filters.

### RADIO CATALOG AND DATA BOOK.

Published by Offenbach Electric Company, San Francisco. 272 pages, illustrated, 7¾ x 10¾ inches.

"This is our first catalog, and we have tried to make it better and more useful than any other catalog hitherto published," says the foreword. Without all previous catalogs before us for comparison, it may be said that this ambitious attempt has been worthily carried out. It is a pleasure to look at this catalog, with its excellent typography. It is filled with much technical advice for the constructor and the Service Man; the materials and equipment listed are accompanied by information which will make their efficient use easier to determine. A part is listed; the circuit for its use is shown; an electroacoustic device is accompanied by its curve; and so forth. This catalog looks like a piece of good printed salesmanship that is profitable to the purchaser; and it may profitably be studied by catalog designers as well as by radio Service Men.

### GENERAL RADIO EXPERIMENTER.

Published by the General Radio Company, Cambridge, Mass. Monthly, 8 pages, 6 by 9 inches. Free distribution.

The February issue of this very interesting home organ for the serious experimenter is devoted to an article by Charles E. Worthen on piezo-electric quartz plates, covering the crystallography and the electrical application of this useful frequency-regulator which is now in demand among amateurs, as well as commercial operators and broadcasters. It will be found interesting by all to whom transmitter regulation is a practical problem.

# Orders - Inquiries

**Can be Secured by MAIL**



**60 pages Send for FREE COPY**

## POLK'S REFERENCE BOOK and Mailing List Catalog

*Gives counts and prices on over 8,000 different lines of business. No matter what your business, in this book you will find the number of your prospective customers listed. Valuable information showing how to use the mails to secure orders and inquiries for your products or services is given.*

**Write for FREE COPY**  
**R. L. POLK & CO., Detroit, Mich.**  
Largest City Directory Publishers in the World. Branches in Principal Cities  
Mailing List Compilers—Business Statistics Producers of Direct Mail Advertising

### CHEMICALS

**BOOKLET OF EXPERIMENTS** and chemical catalog, 15c. General Chemical Company, Box 397, Reading, Penna.

### DETECTIVES

**DETECTIVES Earn Big Money.** Excellent opportunity. Experience unnecessary. Particulars Free. Write, George Wagner, 2190B Broadway, N. Y.

### INSTRUCTION

**BE THE LICENSED RADIO DOCTOR** of your community. Earn \$7.00-\$10.00 spare time evenings. Write now for free booklet, "Why the Radio Doctor?" Radio Doctors, Inc., Dept. C, 131 Essex Street, Salem, Massachusetts.

**LEARN TATTOOING.** Instruction catalog, dime. Miller, X431 Main, Norfolk, Virginia.

### MAGIC

**LESSONS IN MAGIC!!!** Become a real magician—earn Big Money—give entertainments after first lesson. Be popular at all parties. Send 25c. for first lesson. (Worth \$2.00.) Lubasz Magician, S-2968 N. Ridgeway Avenue, Chicago, Ill.

### MEDICAL

**LOST VITALITY** — The Specific Pill and Winchester's Hypophosphites, \$1.00 per box or bottle, postpaid, literature free. Winchester & Company, Established 72 years, Box 237, Mount Vernon, New York.

### OLD MONEY WANTED

\$5 to \$500 EACH paid for Old Coins. Keep ALL old money. Many VERY valuable. Get Posted. Send 10c. for illustrated Coin Value Book, 4x6. Guaranteed Prices. We buy and sell. COIN EXCHANGE, Room 10, Le Roy, N. Y.

### RADIO

**SERVICE MEN, ATTENTION** — Speakers re-wound, magnetized, repaired, \$2.00 to \$2.75. Complete Power Pack Service—Transformers rewound, condenser blocks repaired, resistors duplicated. Guaranteed. Clark Brothers Radio Co., Albia, Iowa.

**SERVICE MEN — EXPERIMENTERS.** Change battery sets into All Electrics for less than \$8. or build new, including tubes for \$14. Complete instructions. 50c. Vesco Radio, 1351 91st Ave., Oakland, Calif.



It's yours  
and FREE

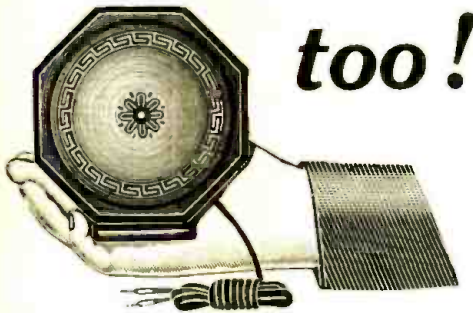

too!

It's just the Midget Cone Speaker that makes radio programs more enjoyable—and besides its clarity of reproduction, its smallness of size makes it convenient to be placed in any room about the house — you get it free, at absolutely no cost. Many thousands are enjoying the advantages of this attractive speaker — why not you?

This speaker is yours — just for entering your subscription to RADIO-CRAFT for one year. Fill in the coupon below. Clip it out and mail it TODAY. There's not an overstock of these wonderful speakers so you must ACT QUICKLY!

Hurry! Fill in Coupon —  
Mail it TODAY.

RADIO-CRAFT, Dept. A  
98 Park Place, New York, N. Y.

My \$2.50 for a year's subscription to RADIO-CRAFT is enclosed. I understand that a Midget Cone Speaker will be sent to me absolutely FREE.

Name .....

Address .....

City..... State.....

**AEROVOX RESEARCH WORKER.** Published by Aerovox Wireless Corporation, Brooklyn, N. Y. Monthly. 4 pages, 8½ by 11 inches, diagrams. Free distribution. The January and February issues of this house organ contain an interesting article by the engineering department of the publisher, on the use of multipliers to increase the range of ammeters and voltmeters. Circuits are shown, and instructions given for the correction of scales and calibration of instruments to any desired range.

**RARE METALS.** Published by Fansteel Products Co., Inc., North Chicago, Ill. 56 pages, illustrated, 6 by 9 inches.

An interesting advertising booklet devoted to the methods of obtaining and using three rare metals. Tantalum, Tungsten and Molybdenum. The second metal, and perhaps the first, will be recognized quickly by the radio fan; but it may surprise him to find the third described specifically as "The Metal of Radio." The explanation is that, while tungsten may provide the filament, molybdenum has qualities equally desirable for the grid. "The reader, if he be a radio fan, will recall that the first tubes were at best rather makeshift. It was by no means uncommon for a grid to soften, lean until it touched the plate or filament, and quietly render a \$6 tube utterly useless. Because molybdenum has made such trouble a rarity, it deserves no small part of the credit due for the greatly improved performance of radio tubes and for bringing down the price." Tantalum, well known as a material in electrolytic rectifiers, is also valuable for tube grids and plates. The book, which embodies much useful information for the engineer, is addressed to the industry, rather than the experimenter. It is interestingly written, attractively illustrated and printed.

**SHIP-TO-SHORE BROADCASTS**

Arrival of the latest German liner *Europa*, which set a new record for a speedy crossing of the Atlantic, was signified by a broadcast from a short-wave transmitter on the bridge of the liner. This was relayed to Europe from Schenectady. Events of this nature are multiplying; and they will continually afford the short-wave broadcast listener the opportunity for many interesting experiences.

**STATEMENT OF THE OWNERSHIP, MANAGEMENT, CIRCULATION, ETC., REQUIRED BY THE ACT OF CONGRESS OF AUGUST 24, 1912.**

Of Radio-Craft, published monthly at Mt. Morris, Ill., for April 1, 1930.  
State of New York  
County of New York

ss. Before me, a Notary Public in and for the State and county aforesaid, personally appeared Irving S. Manheimer, who, having been duly sworn according to law, deposes and says that he is the business manager of Radio-Craft and that the following is, to the best of his knowledge and belief, a true statement of the ownership, management, etc., of the aforesaid publication for the date shown in the above caption, required by the Act of August 24, 1912, embodied in section 411, Postal Laws and Regulations, to wit:

1. That the names and addresses of the publisher, editor, managing editor, and business managers are: Publisher, Techni-Craft Publishing Corporation, 404 North Wesley Ave., Mt. Morris, Ill.; Editor, Hugo Gernsback, 98 Park Place, New York City; Managing Editor, R. D. Washburne, 98 Park Place, New York City; Business Manager, Irving S. Manheimer, 98 Park Place, New York City.

2. That the owners are: Hugo Gernsback, 98 Park Place, New York City; Sidney Gernsback, 98 Park Place, New York City; D. Manheimer, 98 Park Place, New York City.

3. That the known bondholders, mortgagees, and other security holders owning or holding 1 per cent or more of total amount of bonds, mortgages, or other securities are: None.

4. That the two paragraphs next above, giving the names of the owners, stockholders, and security holders, if any, contain not only the list of stockholders and security holders as they appear upon the books of the company, but also, in cases where the stockholder or security holder appears upon the books of the company as trustee or in any other fiduciary relation, the name of the person or corporation for whom such trustee is acting, is given; also that the said two paragraphs contain statements embracing affiant's full knowledge and belief as to the circumstances and conditions under which stockholders and security holders who do not appear upon the books of the company as trustees, hold stock and securities in a capacity other than that of a bona fide owner; and this affiant has no reason to believe that any other person, association, or corporation has any interest direct or indirect in the said stock, bonds, or other securities than as so stated by him.

IRVING S. MANHEIMER  
Sworn to and subscribed before me this 1st day of April, 1930.  
ROZELLA BENNETT, Notary Public.  
(SEAL)  
(My commission expires March 30, 1931.)



How to Build, Test, Repair, Maintain - - Radio Receiving Sets

The three volumes of this Library cover the entire field of building, repairing and "trouble-shooting" on modern radio receivers. The Library is up-to-the-minute in every respect and includes the very latest developments in the design and manufacture of equipment. The rapidly-growing interest in SHORT-WAVE RECEPTION is thoroughly covered in a complete section which deals with the construction of this type of apparatus.

Radio Construction Library

By JAMES A. MOYER and JOHN F. WOSTREL

Faculty, University Extension, Massachusetts Department of Education

Three Volumes — 993 Pages, 6x9  
561 Illustrations

VOLUME I: presents the fundamental principles of radio so clearly and simply that anyone of average training will be able to read, understand and apply them. In one chapter alone, it gives actual working drawings and lists of materials for the construction of eight typical sets.

VOLUME II: fully discusses all of the elementary principles of radio construction and repair. An explanation of the necessary steps for "trouble-shooting," repairing, servicing and constructing radio sets successfully.

VOLUME III: covers the essential principles underlying the operation of vacuum tubes in as non-technical a manner as is consistent with accuracy. It discusses the construction, action, reactivation, testing and use of vacuum tubes; and an interesting section is devoted to remote control of industrial processes; and precision measurements.

EXAMINE these books for 10 days FREE. This Library is not only a thorough home-study course, but a handy means of reference for the most experienced radio experimenter, repair man, and radio shop owner. To these men, as well as to those who desire to advance in the radio profession, this offer of Free 10 days' Examination is made.

Simply clip, fill in, and mail this coupon

McGRAW-HILL  
FREE EXAMINATION COUPON

McGRAW-HILL BOOK COMPANY, INC.  
370 Seventh Avenue, New York.

Gentlemen:—Send me the new RADIO CONSTRUCTION LIBRARY, all charges prepaid, for 10 days' Free Examination. If satisfactory I will send \$1.50 in 10 days, and \$2.00 a month until \$7.50 has been paid. If not wanted I will return them at your expense.

Name .....

Home Address .....

City and State .....

Postion .....

Name of Company..... RC-6-30



# ◆ ◆ Official RADIO SERVICE MANUAL

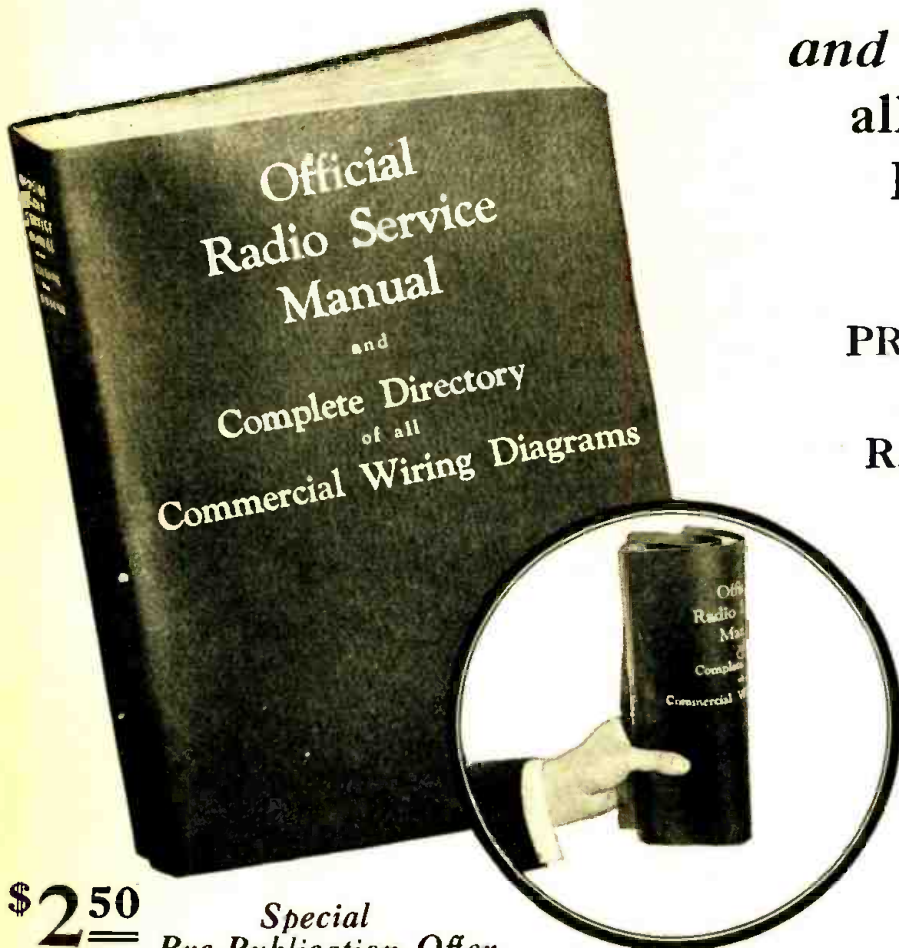

and Complete Directory of  
all Commercial Wiring  
Diagrams of Receivers

PREPARED ESPECIALLY  
FOR THE  
RADIO SERVICE MAN !

HUGO GERNSBACK  
*Editor*

CLYDE FITCH  
*Managing Editor*

**\$2<sup>50</sup>** *Special*  
*Pre-Publication Offer*

**W**E ANNOUNCE the early publication of the long-awaited OFFICIAL RADIO SERVICE MANUAL. This manual is the first complete and most up-to-date book of this kind. Nothing else like it has ever appeared in print.

A tremendous amount of material has been collected, not only for the Service Man, but for everyone interested in radio. A complete directory of every radio circuit of commercial receivers is now possible, and not only to get every circuit of every set ever manufactured, of which there is any record, but in addition, an entirely new idea makes it possible to keep the manual up-to-date.

The OFFICIAL RADIO SERVICE MANUAL is made in loose-leaf form—handsomely made of flexible leatherette—the entire book can be folded and slipped easily into your pocket or put in your bag.

Rarely do manufacturers supply information about receivers made before 1927—even 1930 service data are not always available because many manufacturers do not supply independent Service Men with such data. And, when you can get the material from some of the manufacturers, it is of little use to you because it is not uniform, and it is scattered in different places; difficult to get at.

Additional service data, for new receivers as they appear on the market will be published and supplied at trifling cost so that the MANUAL may be kept up-to-date at all times.

## SERVICE INFORMATION

But that is not all. The OFFICIAL RADIO SERVICE MANUAL contains also a most comprehensive instruction

course for radio Service Men, giving practical information from every angle on how to service sets.

In short, the OFFICIAL RADIO SERVICE MANUAL is the biggest thing of its kind that ever came along in radio. It will be hailed by every wide-awake radio man throughout the entire industry.

The size of the OFFICIAL RADIO SERVICE MANUAL is 9 in. by 12 in. There are several hundred pages, printed on good paper, and the book contains hundreds of illustrations and diagrams.

## SPECIAL OFFER

The price will be \$3.50 upon publication of the book; but to our own subscribers and readers, we have a special pre-publication price of \$2.50, prepaid. This price will be withdrawn the minute the book is published, which will be during the next six weeks or sooner.

GERNSBACK PUBLICATIONS, INC.,  
96-98 Park Place, New York, N. Y.

RC-6

As per your special offer, I enclose herewith \$2.50 for which you are to send me postpaid, one copy of the OFFICIAL RADIO SERVICE MANUAL as soon as it is published, at the pre-publication price of \$2.50. I understand that the price will be \$3.50 as soon as the MANUAL is published.

Name .....

Address .....

City..... State.....



## Radio-Craft's Opportunity Column

TO make this magazine of additional benefit to Service Men, RADIO-CRAFT has instituted a new feature, of which advantage may be taken, free of charge, by any Service Man who has enrolled himself in the NATIONAL LIST OF RADIO SERVICE MEN (by filling out in full the blank which is printed in every issue of this magazine). We will print short notices of the same nature as those which follow; and will forward to the writer of any of them the replies which may be addressed to him (by the number given) in care of RADIO-CRAFT. We can undertake to publish the same notice only once.

We must reserve the right to condense all letters into their most essential details; and we urge all our correspondents who use this service to be as concise, though thorough, as they would be in the composition of a paid advertisement which would cost them several dollars.

Service Men seeking employment should give, at the beginning, the important details which an employer will first ask; and anyone offering employment to a Service Man should be equally specific.

It is desirable that references be given in all letters seeking employment, etc.—not for publication, but in order that RADIO-CRAFT may verify the statements made, if requested to do so, by parties interested in replying to the advertisement.

Please give all information for publication on a sheet of paper separate from the questionnaire, which is filed by us. Age, years' experience, domestic affairs, etc.; and do not forget to put your name and address on each sheet. We have several requests lacking these important details, which we cannot publish as yet. A period of at least one month must elapse between receipt of letters and publication; as the forms of RADIO-CRAFT close several weeks ahead.

We cannot publish under this heading any advertising of a commercial nature—for the sale of goods, or instruction, etc.; or for an employment agency. We cannot publish offers of general servicing for the public, or service representation of a manufacturer in a district. For the former, local advertising mediums are available, and as to the latter, a manufacturer requesting such information will be given it directly from the files of the NATIONAL LIST OF RADIO SERVICE MEN. Announcements seeking or offering regular employment, however, will be accepted under the conditions stated above.

The writers of any of these requests may be addressed as Opportunity No. (number given below), in care of RADIO-CRAFT, 98 Park Place, New York City.

(Opportunity 54) Service Man, high school education; 6 years' radio, one year's service; has own tools and testing equipment and many data; wishes work in Middle West. (Iowa.)

(Opportunity 55) Licensed Operator, second-class, seeks employment. Signal Corps experience as staff sergeant. (Connecticut.)

(Opportunity 56) Service Man and electrician, four years' experience. Available at reasonable notice. Age 23. (Illinois.)

(Opportunity 57) Projectionist, 18 years' experience including radio, pioneer sound operator, qualified for supervisory position with theatre, now employed in first-run house. Age 37. Married. (Connecticut.)

(Opportunity 58) Service Man, nine years' experience. 98% grade on RIA NEMA course, seeks position servicing for dealer or group of stores in small city, preferably Arizona, New Mexico, or other western state. (New York State.)

(Opportunity 59) Service Man, electrician, mechanical drawing course, with own test equipment, wishes to connect with manufacturer to study line and advance. (New York City)

(Opportunity 60) Service Man, graduate N.R.I., in business for self two years, seeks position with manufacturer affording advancement; first salary less important. Anywhere but Chicago. Age 41. Single. (Milwaukee.)

(Opportunity 61) Service Man, one year's experience, graduate RCA Inst., has reached limit of small town business and seeks position with manufacturer or large dealer. Age 21. (Illinois.)

(Opportunity 62) Service Man wishes position as Service-Salesman with distributor or dealer. (Florida.)

(Opportunity 63) Service Man, eight years' experience, own business, amateur and short-wave expert, would like to hear from manufacturer who maintains research laboratory on tubes and short

waves; or from those interested in elimination interference. (Baltimore.)

(Opportunity 64) Service Man, five years' experience, RCA Inst. graduate, wishes employment, preferably on road. Age 20. Single. (Nebraska.)

(Opportunity 65) Service Man, one year's experience, graduate high school, N.R.I., factory experience, wishes position with radio or television manufacturer, affording prospect of engineering study. Starting salary not important. Age 21. Single. (Florida.)

(Opportunity 66) Young man, several years' radio experience, especially battery sets, wishes position with radio dealer as Service Man and repairer. Age 21. (Manitoba.)

(Opportunity 67) Service Man, in business, wishes representation for manufacturer of good receivers. (South Dakota.)

### CLASSIFICATION OF WAVES

How long can a short wave be? That is a question of relativity. In Europe, where they broadcast up to 1875 meters, those waves below 600 meters have for years been called "short"; in this country, those below about 300 meters have fallen into that class, in popular language.

But, by the short-wave fans, anything above 80 meters has for some time been considered "long."

A recent conference of radio authorities in Europe has led to this ruling:

Waves above 3,000 meters (below 100 kc.)—Long.

Waves above 200 meters (below 1,500 kc.)—Medium.

Waves above 50 meters (below 6,000 kc.)—Intermediate.

Waves above 10 meters (below 30,000 kc.)—Short.

Waves below 10 meters (above 30,000 kc.)—Ultra-Short.

### STATIC IS DECREASING

Short-wave reception across the Atlantic has suffered for some months during the past fall and winter on certain wavelengths, as rebroadcasting engineers, amateurs and fans observed; but it is coming back to normal. The coincidence of this phenomenon with sunspot activity confirms the theory which is now generally held; that "storms" on the sun cause magnetic disturbances on the earth, in addition to contributing to the erratic nature of our late weather. The sunspots appear to have a definite eleven-year cycle, with consequent effect on radio reception; and, as the period of maximum activity seems to be over, steady improvement in distant radio reception, and reduced static, may be reasonably expected.

### CHANGE OF WAVE

The French private short-wave station styling itself *Paris Radio Experimental*, which has nightly broadcast on 31.65 meters, has decided to lower its wavelength to roughly 29 meters, in order to avoid interference with existing transmissions. The daily broadcasts begin at 10 p.m. G.M.T. and the power has been increased to 1,200 watts. It is now proposed to carry out simultaneous broadcasts on 40 or 72 meters and in the near future to transmit on 400 meters.—*Amateur Wireless, London.*

### ULTRA-SHORT HAM BANDS

New regulations of the Federal Radio Commission give the entire 28- to 30-megacycle (10,708- to 9,994-meter) and 56- to 60-megacycle (5,354- to 4,997-meter) wavelengths over to amateur use; excluding therefrom commercial and other laboratory experiments.

Amateurs must in future have available direct-current plate supply or its equivalent; and no amateur may have his shack on premises controlled by an alien.

### MARCONI'S LATEST TESTS

A few days ago Senatore Marconi sent from his yacht, the *Elettra*, then in Genoa harbor, a radio signal which operated the switch opening a radio exposition in Australia, almost half round the world.

Prior to that time, short-wave listeners reported extensive tests between the Marconi beam transmitter at Dorchester, England, and the *Elettra*, with phonograph records, on about 25 meters.

## There Are THRILLS A PLENTY on the SHORT-WAVES

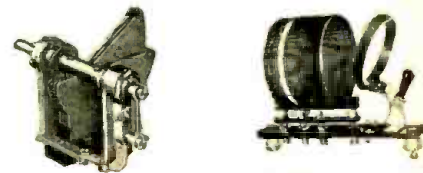

New and unexplored fields are open to the short-wave experimenter. Let Hammarlund help you get the most out of them.

Whether you build your receiver for short-wave broadcast or code reception, remember that quality of parts spells the difference between ordinary results and real thrills.

Your dealer can supply you with Hammarlund Short-Wave Condensers, Plug-in Coils for various wave bands, Chokes, Equalizers, Audio Transformers and Shields.

Experts say, "You can't buy better."

Write Dept. RC6 for folder describing the many new Hammarlund Products.

HAMMARLUND MFG. CO.

424-438 W. 33rd St., New York

For Better Radio  
**Hammarlund**  
PRECISION  
PRODUCTS

## Radio Science Now Eliminates Your Radio Aerial!

BETTERS YOUR RECEPTION!

For all Electric Sets

Radio science has now eliminated the aerial just as it did the messy batteries.

A little Bakelite case 2 1/4 x 4 1/4 that screws on wall or in set cabinet is Radio's Recent Triumph. Brings 'em all in, gives clearer tone, cuts down interference.



Only \$2.50



BUD RADIO, INC.

2744R Cedar Ave.

Cleveland

Ohio

## RADIO BARGAINS

|   |               |
|---|---------------|
| 7-Tube A.C. Sets  | \$26.50       |
| B Eliminator, Bone Dry, with 280 tube, 180 volts, will operate up to ten-tube set, fully guaranteed.  | 8.75          |
| A B C Power Packs   | 4.00          |
| Power and Filament Transformers   | 4.00          |
| Tubes: UX type, 30-day replacement guarantee, No. 210, \$2.25; No. 250, \$2.35; No. 381, \$1.85; No. 215, \$1.75; No. 224, \$1.65; No. 227, 75c; No. 226, 65c; No. 171, 75c. Audio transformers, 75c. Variable condensers, 50c. |               |
| CHAS. HOODWIN CO.   |               |
| 4240 Lincoln Ave. Dept. F-15  | Chicago, Ill. |
| DEALERS IN BANKRUPT RADIO STOCKS  |               |



# Radio-Craft's Information Bureau

(Continued from page 648)

**Eliminate Your Radio Aerial**



For all electric sets. Radio science's recent triumph in eliminating unsightly wires about the home. A little Bakelite case that screws on wall or cabinet of set. Brings 'em all in, gives clearer tone, cuts down interference.

**BUD ANTENNA ELIMINATOR**  
only \$2.50

BUD RADIO, INC.  
2744R Cedar Avenue  
Cleveland Ohio

Write for Information about the **NEW H-F-L MASTERTONE**  
LABORATORY MADE RECEIVER  
*The Year's Outstanding Radio Achievement*  
HIGH FREQUENCY LABORATORIES  
28 N. Sheldon St. Dept. 77 Chicago, Ill.

**BRAXTON-KING SCREEN GRID**  
A. C. Superheterodyne Tuner will work with any two-stage amplifier  
Write for Information  
MISSISSIPPI VALLEY RADIO CO.  
914 Pine St., Dept. A, St. Louis, Mo.

**Screen Grid Auto-Radio**  
Be among the first to have an Auto-Radio. Manufactured specially for operation in Automobiles, Airplanes, and Motor Boats. A six-tube neat compact set, marvelous tone, single-dial control. Fits any car. Installed easily by anyone. Price, including tubes \$49.50  
TRAVELTONE AUTO-RADIO MFG. CO.  
2019 S. Wabash Ave. Dept. A-50 Chicago, Ill.

**WE MATCH PANTS To Any Suit!**  
Double the life of your coat and vest with correctly matched pants, 100,000 patterns. Every pair hand tailored to your measure; no "readymades." Our match sent FREE for your O. K. before pants are made. Fit guaranteed. Send piece of cloth or vest today. SUPERIOR MATCH PANTS COMPANY  
115 So. Dearborn Street, Dept. 377, Chicago

**MAKE BIG MONEY**  
Just out. Lights gas instantly without sparks or flame—Sells like wildfire wherever gas is used—Retail for 25c.  
**MYSTERY GAS LIGHTER**  
PACKED ON IN INDIVIDUAL CARDS WITH INSTRUCTIONS  
Sample free or rush \$9.00 per gross or \$1.00 per dozen. NEW METHOD MFG. CO., Desk SFG-6, New Method Bldg., Bradford, Pa.

**SONG WRITERS!**  
Substantial Advance Royalties are paid on work found acceptable for publication. Anyone wishing to write either the words or music for songs may submit work for free examination and advice. Past experience unnecessary. New demand created by "Talking Pictures", fully described in our free book. Write for it Today—Newcomer Associates  
751 Earle Building, New York, N. Y.

ample, could be improved by this circuit arrangement?

(A.) The superheterodyne incorporates an amplifier which is tuned (at least at its input and output) in such a manner that its stages are called on to handle only one frequency range; this is brought about by "changing the frequency" of the signal. On the other hand, the "untuned" R.F. amplifier is designed to accept, and amplify with as little discrimination as possible, any frequency in the broadcast band. This subject was discussed quite thoroughly by Mr. Grimes in the Cooperative Radio Laboratory section of RADIO-CRAFT (page 458 of the March issue, with illustrative diagrams).

The "untuned" R.F. amplifier (as a matter of fact, every circuit containing resistance, capacity and inductance is tuned to some frequency; and the "untuned" or "aperiodic" circuit is really one that is working a long way from its natural frequency) was in favor in the early day. The need for selectivity led to tuning the R.F. stages; and now we have tuning devices—such as a hand-pass filter—separated from the amplifying stages (as in Fig. Q64B).

In some designs of superheterodyne, the "intermediate-frequency" output of the frequency-changer is at high R.F. frequency, such as that used on the broadcast band; and the "untuned R.F. amplifiers" suggested by Mr. Bell could be used. The only advantage is that, under varying conditions, met with in different locations, the operator could choose the intermediate frequency best adapted to avoid station interference. It is necessary that the intermediate frequency, whatever it may be, shall be evenly amplified over a band of ten kilocycles, or so, and that the undesired station frequencies be kept out of this amplifier.

## TRANSFORMER TROUBLE—INDUCTOR DYNAMIC—RUSHING SOUNDS

(65) Mr. J. R. Hope, Banff, Alta., Canada.  
(Q.) In a set having low volume, I found that placing my fingers across the first A.F. primary brought the volume up to normal. Continuity tests, etc., failed to indicate any defect in the transformer. Condensers and resistors across the primary failed to be of any use. Could you explain such a case?

(A.) It is probable that the correct voltages were not being supplied to the tubes. Whenever a signal of even moderate amplitude reached the grid of the first A.F. tube it overloaded the grid which, operating at the wrong point on the characteristic (for lack of sufficient "B" or "C" potential) choked up. Reducing the input by shunting the primary with a resistance kept the input to the tube within the working limits of the first stage of A.F.

Also, a defective transformer might cause such a condition, by leakage between primary and secondary, whereby the signal energy transferred is in inverse proportion to the amount of energy input, due to leakage. A similar effect is sometimes caused by a defective socket. It is assumed that the tube has been tested, or replaced, to see that it is not the source of trouble.

Occasionally it is desirable to supply the lack of an R.F. choke coil in the detector plate lead, and by-pass it to ground with a condenser. This condenser may have a (fixed) capacity of about .0005-mf. or .001-mf. The purpose is to prevent R.F. energy getting to the A.F. circuits.

Another cause of trouble may be an open circuit in the primary, that is partially closed through a high resistance. Testing for continuity with a high-resistance voltmeter would give an indication that might seem to indicate a perfect winding; while under the load of the tube the current passed through the circuit would be too little. Of course, a simple "cut-and-try" method of proving the case is to substitute another transformer for the questionable one. If this remedies the trouble, the defective unit may be sent to the makers for test and report by their laboratories.

(Q.) How does the "inductor dynamic" reproducer operate?

(A.) A full description of this type of speaker (in the September, 1929, issue of RADIO-CRAFT) may be boiled down to the statement that an iron armature, instead of being attracted to the magnet in what might be called a "to and fro" direction (Fig. Q65A) is arranged to move from side to side, in a "swing past" motion (Fig. Q65B). Because

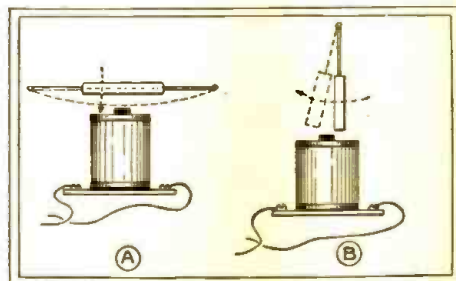

(Fig. Q65.) In the ordinary magnetic speaker, the armature's swing brings it up to the pole-piece, as at A; in the inductor dynamic, it moves across the pole-piece, as at B.

of this, the armature cannot hit the magnet, but must always swing past it. This is clearly shown in the simplified illustration herewith.

(Q.) How can I reduce an intense rushing sound, which is continuously present in the speaker of an Atwater Kent "Model 35" receiver?

(A.) Rushing sounds in speakers may be generally classified as due to: defective "B" supply; noisy tubes; noisy "C" battery; poor contacts; or interference pick-ups. There should be no difficulty in checking the latter possibility by listening-in at the detector output, or by substituting another set.

The former faults may require some time to test out. The most simple way to proceed is to determine whether the fault lies in the R.F. unit, the detector, or the A.F. unit; no explanation should be needed as to this procedure. After localizing the trouble, it may be found in: a leaky by-pass or filter condenser; a leaky A.F. transformer; a poor "A" contact; dirty tube-prongs or socket-springs; leakage between wiring leads; one defective cell in the "B" or "C" units (if batteries are used); a defective grid leak; or feed-back in either the A.F. or R.F. circuits (not a very usual cause). Defective phone cords may cause the reported effect; since a cord may absorb moisture, or some of its conductors may break and cause crackling sounds.

## "SINGING" A.F. CHOKES

(66) Mr. Frank Benton, Brooklyn, N. Y.  
(Q.) I have bought several audio chokes which soon developed characteristics of a "singing transformer" on strong signals. Am using two '71As in push-pull with 180 volts of Willard storage "B" batteries, in the manner shown (Fig. Q66). Would a 2-amp. audio choke of the "A" eliminator type have the proper characteristics; or would an 80-ma. audio choke be more practical?

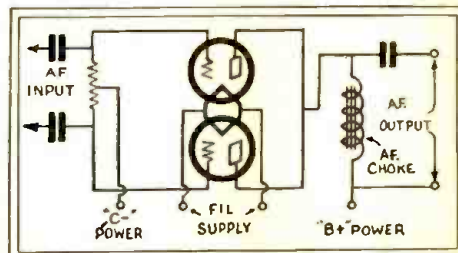

(Fig. Q66.) Mr. Benton's circuit, which this department does not recommend, is not push-pull.

(A.) "A" eliminator choke coils are quite unsuitable as audio-frequency choke coils, because of their low inductance under reduced current. Singing in A.F. units is traceable to either the mechanical motion of laminations (remedied by tightening or wedging them) or circuit oscillation (remedied by filtering, by-passing, changing transformers, damping circuit with resistors or detuning with small condensers, neutralizing the circuit, or re-locating the parts).

## TUBE TESTING DATA

(67) Mr. Raymond Shaw, Decatur, Ill.  
(Q.) What should be the value of R (in ohms) in Fig. 1, as shown in the article "Vacuum Tubes for Radio Reception," on pg. 322, Jan. 1930, issue



# And NOW—

Remember that EVERYDAY MECHANICS stands for practical mechanics in all its phases. And still more important, this magazine is the only one ever published where nearly all of the material published is edited with the view that its readers can cash in on the ideas.



# 15c

The Copy

OUT  
JUNE 1ST

On All  
Newsstands

**H**ERE is the latest and most up-to-date magazine of its kind that has ever been published. Edited by Mr. Hugo Gernsback, veteran publisher of radio and scientific magazines for over 20 years.

The new magazine is chock-full of the latest inventions, new developments, how-to-make-it material, home mechanics, woodworking, metal craft, radio experimentation, etc.

But the important point about this new magazine is that it is thoroughly practical from beginning to end. No theories, no scientific accomplishments, no reading material that is not 100% practical in everyday life.

The magazine contains dozens of valuable articles showing how you can make things not only for yourself but how you can make money out of them immediately—that's the big thing.

The first issue of this magazine will be out on June 1st. Or if you wish to take advantage of several fine offers for a year or two-years' subscription, fill in the coupon at the right.

**EVERYDAY MECHANICS PUBLICATIONS, INC.**  
96-98 Park Place New York, N. Y.

## A Special Offer

and saving are made for readers of this magazine. EVERYDAY MECHANICS will be sent to you for one year at \$1.00; two years at \$1.90; and three years at \$2.70. Remember each issue bought on the newsstand costs fifteen cents the copy.

## Mail Coupon Today

EVERYDAY MECHANICS PUBLICATIONS, Inc.  
96-98 Park Place, New York, N. Y. RC-6

I wish to take advantage of your special offer. Enclosed find.....for which send me EVERYDAY MECHANICS for.....years. Check one of the following.

- ( ) 1 year for \$1.00 ( ) 2 years for \$1.90  
( ) 3 years for \$2.70

Name .....

Address .....

City..... State.....



# Over the Mountains from Los Angeles



Think of it! FIVE HUNDRED FIFTY-NINE MILES over rough mountainous country burning only ELEVEN GALLONS OF GASOLINE. Imagine more than FIFTY MILES TO THE GALLON. That is what the WHIRLWIND CARBURETING DEVICE does for D. R. Gilbert, enough of a saving on just one trip to more than pay the cost of the Whirlwind.

## THE WHIRLWIND SAVES MOTORISTS MILLIONS OF DOLLARS YEARLY

Whirlwind users, reporting the results of their tests, are amazed at the results they are getting. Letters keep streaming into the office telling of mileages all the way from 22 to 59 miles on a gallon, resulting in a saving of from 25% to 50% in gas bills alone.

Mark A. Estes writes: "I was making 17 miles to the gallon on my Pontiac Coupe. Today, with the Whirlwind, I am making 35.5-10 miles to the gallon."

P. P. Goerzen writes: "34-6-10 miles with the Whirlwind, or a gain of 21 miles to the gallon."

K. J. Tulip: "The Whirlwind increased the mileage on our Ford truck from 12 to 26 miles to gallon and 25% in speed."

Car owners all over the world are saving money every day with the Whirlwind, besides having better operating motors. Think what this means on your own car. Figure up your savings—enough for a radio—a bank account—added pleasures. Why let the Oil Companies profit by your waste? Find out about this amazing little device that will pay for itself every few weeks.

### FITS ALL CARS

In just a few minutes the Whirlwind can be installed on any make of car, truck or tractor. It's actually less work than changing your oil, or putting water in your battery. No drilling, tapping or changes of any kind necessary. It is guaranteed to work perfectly on any make of car, truck or tractor, large or small, new model or old model. The more you drive the more you will save.

**SALESMEN AND DISTRIBUTORS WANTED  
FREE SAMPLE AND \$100.00 A WEEK OFFER**

Whirlwind men are making big profits supplying this fast selling device that car owners cannot afford to be without. Good territory is still open. Free sample offer and full particulars sent on request. Just check the coupon.

### GUARANTEE

No matter what kind of a car you have—no matter how big a gas eater it is—The Whirlwind will save you money. We absolutely guarantee that the Whirlwind will more than save its cost in gasoline alone within thirty days, or the firm will cost you nothing. We invite you to test it at our risk and expense. You are to be the sole judge.

### FREE TRIAL COUPON

Whirlwind Mfg. Co.,  
999-247-A Third St., Milwaukee, Wis.  
Gentlemen: You may send me full particulars of your Whirlwind Carbureting device and free trial offer. This does not obligate me in any way whatever.

NAME .....

ADDRESS .....

CITY .....

COUNTY .....

STATE .....

( ) Check here if you are interested in full or part time salesman position.

## WORLD-WIDE SHORT WAVE RECEIVER

Span the World with this Set!

ONLY \$6.45

A new radio thrill for you! Listen in DIRECT to London, Paris, Berlin, Buenos Aires and other broadcasting stations throughout the world via short waves. Enjoy unique foreign programs from strange lands. Your ordinary receiver cannot tune in these low-wave stations. WORLD-WIDE RECEIVER gets 30 to 550 meter stations with surprising clarity.

**SEND NO MONEY!** Just write your name and address on a postcard and ask us to send you this wonderful guaranteed short-wave set. Pay postman \$6.45 plus a small delivery charge. Write today!

CHAS. HOODWIN CO.

4240 Lincoln Ave. Dept. F-150 Chicago, Ill.

## Help For the Radio Worker

Learn from the experience of OTHERS. Give fellow-workers the benefit of YOUR experience. The ELECTRAD FORUM is the organization that brings you together. Dues, \$5 per year, include unique monthly magazine of inestimable value. Write Dept. RC-6 for details and application blank.

**ELECTRAD FORUM**  
1440 Broadway, New York

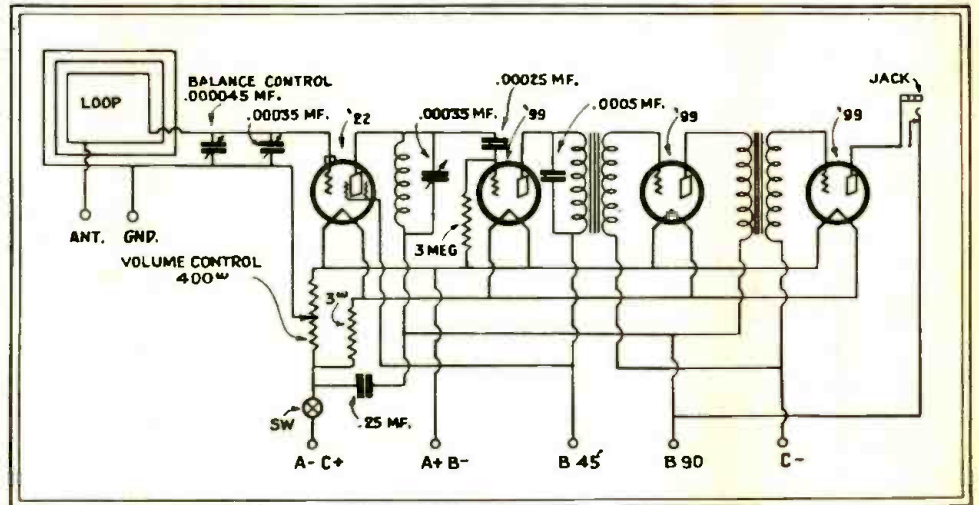

(Fig. Q68.) Schematic circuit of the "Tom Thumb" Portable, in its screen-grid model; dry cells supply the "A" current. A built-in loop antenna is used.

of RADIO-CRAFT (in which a "simple tube tester" is described), to test all standard tubes?

(A.) The resistor R used in the mutual conductance tester which was described in that article (by Mr. C. W. Palmer) should have a value of 1,500 ohms. Any wire-wound or carbon resistor of good make may be employed and calibrated as described in the article.

(Q.) What should a meter (scale 0-10 milliamperes) read when R is correctly adjusted to "show no change"?

(A.) The plate current reading at "no change position" will be somewhat less than the normal plate current for the tube. The actual plate current depends entirely on the tube, and the voltages supplied to it.

(Q.) Should not the third (and fifth) equation:

$$\frac{I}{E_g} = \frac{I}{R}$$

read, instead,

$$\frac{I}{E_g} = \frac{I}{R}$$

(A.) The two changes that you suggest should be made: as the original contained typographical errors. The formula represents simply Ohm's Law in this shape:

$$\frac{I}{E} = \frac{I}{R}$$

### CAR-RADIO LAWS—AUTOMOTIVE RADIO—"TOM THUMB" PORTABLE

(68) Mr. Charles Bencivenga, Brooklyn, N. Y.  
(Q.) Is there any regulation that would prohibit my installing a radio receiver in my car?

(A.) There is no such regulation in the State of New York. However (as pointed out by Mr. Gernsback, writing in the May issue of RADIO-CRAFT) such regulations are in force in other states, notably Massachusetts and New Hampshire. We also note that, under the provisions of a new law in Michigan, a fine of \$1,000 or imprisonment for six months, or both, is the punishment for equipping, or using, an automobile with a short-wave receiving set unless the car is used or owned by a peace officer or unless a permit is granted by the police authorities. The law was enacted to prevent the receipt of broadcast warnings by those for whom the Police Department are instituting search. (All the Detroit police cars are equipped with radio apparatus). The constitutionality of these regulations is another question.

(Q.) Is it possible to install an ordinary five-tube battery set in an automobile?

(A.) A regular radio receiver of any type suited to the available power supply, may be installed in a car; although it is advisable to use one of exceptional sensitivity if really satisfactory results are to be expected. Then again, it is usually desirable to design a compact receiver that will fit more closely into the available space, than the average set.

An aid toward convenient location of such a set is the use of "remote tuning," and this necessi-

itates special construction. Details of modern automotive radio installations have appeared in the February, March and May issues of RADIO-CRAFT, as well as elsewhere in this number.

(Q.) Please show the schematic circuit of the "Tom Thumb" screen-grid portable set, with component values.

(A.) The diagram of the screen-grid model of this compact set is shown in this department.

### DX WITH OLD-STYLE SET

Editor, RADIO-CRAFT:

In reply to the inquiry of Mr. E. M. Welling in the December issue, I wish to say that I also use a set with six '99-type tubes; and I agree with him that distance lies in the tubes used, and not the hookup. I have verifications from every state except South Carolina, and every Canadian province except Prince Edward Island. I have picked up 25 stations in Cuba, 17 in Mexico, 55 in Canada and 710 in this country. Here is a list of foreign stations from which I have had a letter of verification. (List of fifteen foreign countries, including Australia, India, Japan, New Zealand, South Africa, Hungary, Switzerland, Sweden, Denmark, Austria, Spain, Germany, England, and Brazil.) Would you consider this much of a record?

EDWARD C. BARRETT.

20 Grant Avenue, Manoa Heights, Llanerch, Penn.

(Some extraordinary reception is attained in certain places; but any such record as this is not to be obtained, with the most powerful sets, except in a few favored locations. The only effective comparisons are those between two receivers on the same antenna—or the same receiver on two different antennas.—Editor.)

### PREFERS THE PERIDYNE

Editor, RADIO-CRAFT:

After 18 months' operation, with every station of consequence on my log, perfect tone, ease of tuning, and volume enough to dance by, I want to thank you for the Peridyne circuit. I have heard most of the late receivers, but none compare with it in tone. I like the battery set best; as I believe it to be more quiet. Furthermore, no other receiver I have ever heard has its selectivity; it will separate any stations that can be separated.

GRAHAM M. LYLES.

422 Kentucky Ave., S. E., Washington, D. C.

### ANTIPODAL BROADCASTING

The return of the Byrd Antarctic expedition was signalized by the longest two-way radio broadcast yet effected, on March 11-12. The welcome from Schenectady was relayed from Sydney, Australia, and thence by wire from Wellington to Dunedin, New Zealand; and broadcast in three continents. The reply of Admiral Byrd, who heard perfectly, was somewhat affected by "summer static" in the Tasman Sea between Australia and New Zealand. The two-way conversation was photographed on talking film for future reproduction.



# Radio's Greatest Bargains!

THESE are the greatest radio set bargains that have ever been offered. The radio sets listed here are standard sets made by the greatest and best known radio set companies in America.

All of these sets are battery sets (with the exception of the Freshman All-Electric A.C. Set); but this is only one reason why they are sold at such ridiculously low prices.

The other reason is that these sets are mostly demonstration and display models from New York's largest radio and department stores.

We have been able to make connections with a number of houses in New York City, and we secured these fine sets at remarkable prices. Due to these circumstances, we are enabled to sell them to you at only a fraction of their original cost.

**IMPORTANT!—SET BUILDERS, CONSTRUCTORS AND EXPERIMENTERS TURN THESE SETS INTO BIG MONEY!**

There are still many families and many houses not equipped with radio today. At the

prices at which we are selling them, it will pay you to install these sets and sell them at an excellent profit.

A number of our customers have made as much as \$20.00 and \$30.00 on each one of these sets by installing them. Incidentally making a profit on tubes, loud speakers, etc.

Remember, we do not sell you these sets as brand new. They all have been used somewhat, but they are all in excellent condition, and, by going over the cabinets with some furniture polish, or otherwise renovating them, they will make a first-class appearance and, in most instances, you will not be able to tell the set apart from a new one. This is your great opportunity to make a few extra dollars, and we trust that you will not let this opportunity go by.

We promise reasonably prompt shipments. We have a large supply of these sets on hand, and, in most cases, can ship within 24 to 48 hours.

**ALL SETS ARE TESTED BY OUR EXPERTS AND WE GUARANTEE THEM TO WORK SATISFACTORILY.**

## STROMBERG-CARLSON 523 RECEIVER

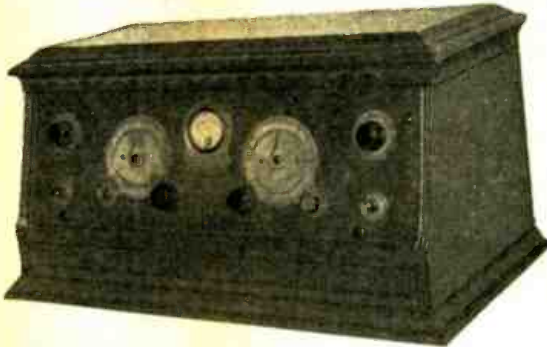

ONLY  
\$  
**24.95**

This model of the famous "Treasure Chests" was one of the first to introduce the idea of electrification. Four 201A tubes and one 200A were recommended; all operating voltages to be supplied from an external power unit operating from the light socket, such as the No. 403 Audio Power Unit. (Of course, regular batteries may be used.) A beautifully-grained slanting wood panel carries the well-known phosphor bronze tuning and control escutcheons. The panel controls include a "Long-Short Antenna" switch, and a Weston 0-7 voltmeter. Jack on panel is for phonograph pick-up. Neutrodyne circuit is used. Weight is 30 lbs. Cabinet is 20 in. long x 14 in. deep x 13 in. high. Its appearance is unusually attractive. Makes a fine appearance in any home. The chassis of this set is the same as the one used to complete the No. 524 Console that listed for \$230.00. Circuit will accommodate either a 112A or a 171A without any changes in wiring. List price is \$160.00.

## FRESHMAN ALL-ELECTRIC RADIO FOR 110-VOLT A.C. OPERATION



ONLY  
\$  
**31.95**

This is a brand new and unused set. It comes in the original factory case. The latest and best of the famous Freshman all-electric radio sets. It is a 1929 model. This set uses 1 type 227 tube, 4 226s, a 250 and a rectifier of the 281 type. The power pack is contained in a small shielded case at the rear of the chassis and within the cabinet; thus, it is an entirely self-contained electric receiver. All equipment is housed in a gold and crystalline olive finished metal cabinet 19 in. long x 10 in. high x 12 in. deep; set weighs approximately 35 lbs. The Freshman Electric Radio supplies the demand for a simple, neat-appearing, illuminated single-dial control, entirely self-contained, shielded, all-electric radio set. List price is \$90.00.

## RADIOLA 20



ONLY  
\$  
**12.50**

Two stages of tuned radio frequency amplification, a regenerative detector, and two stages of A.F. amplification, using 4 type 199 tubes and a 120 for the last audio stage, is the arrangement of this receiver. A marvel for sensitivity. Made by Radio Corporation of America. Like the big superheterodynes of the same make, drum dials are used. Three variable condensers are used and these are ganged, and adjusted by the left-hand or "station selector" dial. The two L.F. stages are NEUTRALIZED. Two jacks are provided; a choice of one A.F. or two is obtainable. Two small black knobs on the lower right are controls which vary the filament circuit resistance, and two similar knobs at lower left are controls for 3-plate balancing condensers. Cabinet is mahogany. The tube sockets are mounted in a slanting strip of bakelite. This strip is supported on sponge rubber. A terminal strip is provided, to which is fastened one end of a 7-wire battery cable 5 ft. long. The clever constructor can adapt this chassis to short-wave operation by mounting sockets for plug-in coils, and by doing a bit of engineering with the variable condensers. Overall dimensions are: 19 x 16 x 11 inches high. It weighs 29 pounds. List price is \$102.50.

## ATWATER KENT MODEL 35



ONLY  
\$  
**14.95**

One of the most compact receivers ever offered to the public. It is of the tuned radio frequency type. The first stage of R.F. is untuned and acts as a "blocking" tube. Circuit oscillation is prevented by the use of grid suppressors, of which two are provided. There is a total of three stages of R.F. amplification and two of A.F. Three variable condensers are used. Overall dimensions are: 17 1/2 x 8 x 5 1/2 inches. The chassis is housed in a brown, crackle-finish dressed metal cabinet. This is a "one-dial control" receiver. A "full vision" moulded bakelite dial controls the variable condenser gang; another moulded control varies the filament heat. It weighs 12 pounds. Incorporated in this set is a 6-wire cable, each wire of which is rubber insulated and "color coded." A power tube may be used in the last stage. Phosphor bronze "belting" couples the two slide condensers to the central one, upon the shaft of which the tuning dial is fastened. This shielded receiver has very high "gain" and may be used with antennas of any length. The variable condensers are of the "single bearing rotor" type. This set takes the following tubes: 5 type 201A and one type 112A or 171A tubes. List price is \$65.00.

## FRESHMAN "MASTERPIECE" TYPE E



ONLY  
\$  
**11.95**

This is a single-dial receiver (what everyone wants) and, like the A.K. 35, it uses a phosphor bronze "bell" to couple the three 19-plate brass variable condensers. Six tubes are required for this set. Easy to turn over at a big profit. Its overall dimensions are: 20 x 10 x 10 inches high, and the slanting panel measures 7 x 18 x 1 1/2 inch. It is of brown crackle-finish metal. Weight of set is 21 pounds. The escutcheon in the middle of the panel has an opening through which the dial setting may be seen; a semi-circular rheostat for volume control is adjusted by the small knob to be seen below the tuning knob. At the extreme left is a little 13-plate condenser connected from grid to filament of the first R.F. tube, for obtaining distant station programs. The first R.F. is untuned, while the second and third are tuned; circuit oscillation being prevented by the use of grid suppressors. This set is designed to be used with five type 201A's and a type 112 tube. The cabinet is of two-tone mahogany veneer, with a nickel-plated, full-length piano hinge. List price is \$89.50.

ONLY  
\$  
**5.00**



This is distinctly a Custom Built set. Where it was thought that a change of parts would improve the performance of the receiver, the change has been made. Although, in the main, the circuit is that of the famous "Masterpiece." There are three standard R.F. coils, and three standard Freshman variable condensers (19 plates) made with brass plates. The panel is mahogany hard-rubber, 7 x 18 x 3/16-inch thick; the baseboard is the same size and material. A Cutler-Hammer push-pull snap switch is used. Ample volume control is obtained with the two panel-mounted rheostats. One is 25 and the other is 10 ohms. Two phone jacks are provided for loud speaker connection to first audio or second audio output. Seven battery connection binding posts are mounted on the rear of the baseboard. The dials are black, moulded. This set takes five type 201A tubes. Total weight is 12 pounds. The overall dimensions are: 20 1/2 x 9 x 6 inches high. The cabinet is finished in mahogany, to match the panel. The set lists for \$60.00.

## HOW TO ORDER

Remit amount by money order, cash or certified check (personal checks occasion delay). Order direct from this page at prices quoted. No. C.O.D. orders on this sale accepted.

# RADIO SPECIALTY CO.

BUY FROM RADIO'S OLDEST MAIL ORDER HOUSE

98C Park Place  
New York City



# AERO SHORT-WAVE Automatic TUNING UNIT

(Protected by patents pending)

## Exclusive Features

*W. H. Hoffman and Don H. Mix, than whom there are no better known short-wave experts, are the designers of this tuner.*

Automatic range, 15 to 90 meters; full range, up to 200 meters.

No plug-in coils used in automatic range.

Easiest tuning device known.

Tunes even more slowly than broadcast receiver.

Special attachment enables it to reach 200 meters.

Anyone can operate it.

The days of fooling with plug-in coils are over. Amateurs can now have a real thrill by this new automatic tuning device. Read the complete story in February QST and May RADIO-CRAFT, and then mail your order to Aero Products for the complete built-up unit. Be first to use this remarkable short-wave apparatus.

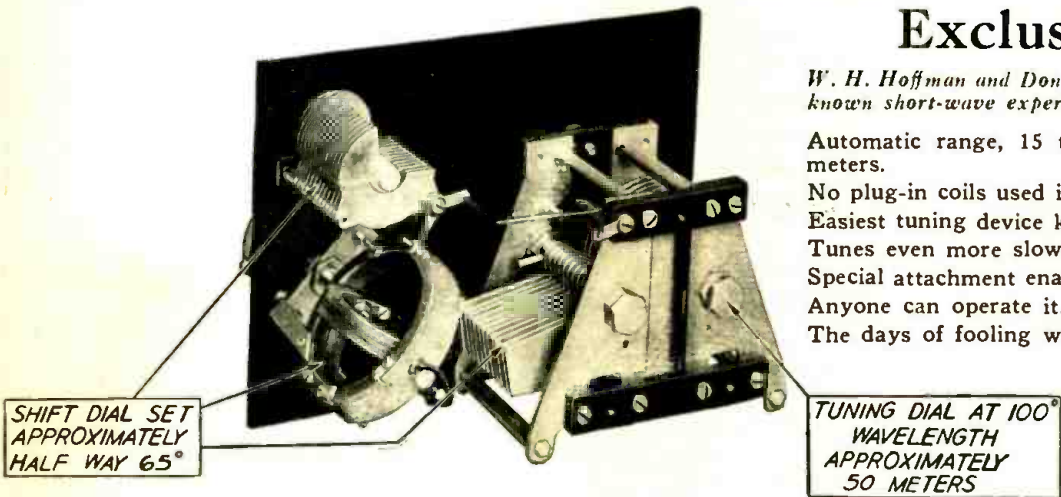

## A Marvelous Improvement

### NO PLUG-IN COILS

Range 15 to 90 meters. Easiest tuning short-wave receiver known. The tuning unit consists of two controls. The right-hand control, which will be termed the shift control, and the left-hand control, the actual tuning device. In addition to these two controls it will, of course, be necessary to have a regeneration control.

For those who desire to employ it for television or the upper phone band, a special attachment may be secured.

### OPERATION

The tuner is operated in the following manner. As a specific example, with the right-hand dial set at nine degrees, revolving the left-hand dial through 180 degrees, you will cover from 19.1 to 22.6 meters. The next step will be to move the shift dial to 13 and tuning over 180 degrees, as before, this time covering from 21.9 to 25.7 meters. This process is continued through 180 degrees on the shift dial until you have reached the maximum automatic wave length, which is 90 meters.

You will note that the tuning dial, in the first instance when tuned through 180 degrees, covers only 3½ meters, whereas ordinarily when using plug-in coils your tuner, when passing through 180 degrees, generally covers at a minimum of 25 meters. This same speed of tuning is maintained throughout the entire short-wave spectrum, and it is for this reason that this tuning arrangement surpasses any known method.

This unit is furnished completely assembled to the amateur, and may be built into either a short-wave converter or receiver.

*For those desiring to go from 90 to 200 meters a special device may be had, making its range then from 15 to 200 meters. Net price of attachment, \$5.90 extra.*

A general chart is furnished with each unit specifying the settings for the shift dial, which will enable you to approximate the wave length for each setting on the shift dial.

This tuner is not sold through the usual trade channels, but is sold to amateurs only direct from factory at special low net price. Be sure to send post office or express money order for \$19.50 with your order. Shipments will be made in order received. Be first to order. Attach your money-order to coupon below and mail today — NOW!

### AERO PRODUCTS, INC.

4611 E. Ravenswood Ave., Dept. 2550, Chicago, U. S. A.

Dear Sirs:

I want to be one of the first to secure the new Aero Short-Wave Automatic Tuning Unit. Enclosed is money order for \$19.50 which is your low opening net price to amateurs only.

Name .....

Street and No. ....

City..... State.....

## PRICE ONLY

# \$ 19.50 NET

### AERO PRODUCTS INCORPORATED

4611 E. Ravenswood Avenue

Dept. 2550

Chicago, Illinois, U. S. A.



# WHAT EVERY ELECTRICIAN WANTS TO KNOW!

**JUST OUT!**—Latest Exact Information from A to Z!

We take pleasure in announcing: "AUDELS NEW ELECTRIC LIBRARY"

New and More Uses for Electricity offer great opportunities to men who can handle this power correctly. Modern electrification of industry calls for trained men who know how to handle electricity accurately.

Simple as A. B. C.—"Audels New Electric Library" gives latest, exact information from foundations of electrical practice to latest modern applications. This is a NEW practical and theoretical course in electricity for home study and ready reference.

Here are the answers to your questions, giving you the real dope that every electrician must know. They chart your knowledge, taking away the uncertainty of guess work.

**NEW!**

As Easy As ABC



Latest information, fully illustrated, covering:—

Fundamental Principles and Rules of Electricity, Magnetism, Armature Winding, Repairs, Dynamos, D.C. Motors, Construction, Installation, Maintenance and Trouble Shooting, Tests and Testing Instruments, Storage Battery, Construction and Repairs, Alternating Current Principles and Diagrams, Power Factor, Alternators, Transformers, A.C. Motors, Windings, Reconnecting, Converters, Switches & Fuses, Circuit Breakers, Relays, Condensers, Regulators, Rectifiers, Meters, Switchboards, Power Station Practice, House Light & Power Wiring, Circuits, High Tension, Transmission, Plans, Calculations, Code. Electric Railways, Signals, Elevators, Hoists & Cranes, Gas Engines, Auto & Aero Ignition, Starters, Radio, Telephone, Telegraph, Bells & Signals, Motion Pictures, Talkies, Lighting, Illumination, Electric Refrigeration, Heating, X-Ray, Plating, Welding, Pumps, Compressors, Domestic & Farm Appliances, An Electric Calculator for Engineers and Mechanics, Practical Mathematics for Ready Reference, A New Electric Dictionary & Encyclopedia of Words.

**7** Books Now on Sale **5** in Preparation

The Library contains 12 books—the first 7 books containing 3600 pages with thousands of diagrams and illustrations are now ready; the remaining 5 books are in preparation. A pocket-size, flexibly bound series that is valuable wherever electricity is used.

Beautiful, timely books for service—pocket size; completely illustrated with diagrams and charts; simplified, easy to read and understand. No electrical man can afford to pass up this opportunity. Extremely low price; buy on your own terms.

Beautiful, Timely Books



Read for Profit

**BUY ON YOUR OWN TERMS**

- PLAN 1—ONE BOOK A MONTH**  
Please enter my subscription to "Audels New Electric Library" to consist of twelve volumes, price \$1.50 a volume (\$10.50 for the seven volumes now ready). Mail one volume each month and as they are received, I will mail you \$1.50 promptly.
- PLAN 2—PAY 50c OR MORE A WEEK**  
Please ship me for one week's free trial the first seven volumes of "Audels New Electric Library," \$1.50 each (\$10.50 for the seven volumes now ready). The remaining five volumes to be mailed as issued at \$1.50 a volume. If satisfied, I will mail you 50c or more each week as payment for the first seven books and I will pay for the last five numbers as I receive them at \$1.50 each.
- PLAN 3—CASH PRICE \$9.98**  
Please ship me postpaid "Audels New Electric Library" for which I enclose remittance \$9.98 in full payment for the seven volumes now ready. You are to ship me on one week's trial the remaining five volumes as they are for which I will either pay \$1.50 each as received or return to you. This price is based on 5% cash discount.

THEO. AUDEL & CO.,  
65 West 23rd St., New York, N. Y.

Please ship me the NEW "Audels Electric Library" on the plan marked (X).

NAME .....

ADDRESS .....

OCCUPATION .....

EMPLOYED BY..... Ger

QUESTIONS AND ANSWERS  
**AUDELS NEW ELECTRIC LIBRARY ILLUSTRATED**

**NEW!**

**SATISFACTION GUARANTEED!**  
"Audels New Electric Library" is backed by our 50-year record as helping hand publishers. Satisfaction always guaranteed.



# JEWELL SET ANALYZERS

## Pave the Way to Service Profits

**No. 579 Service Test Panel  
with Remote Control Box**



Another outstanding achievement by Jewell—an instrument unequalled in speed, accuracy, and convenience for radio service testing. Read these features:

Remote control box with push button switches makes for rapid, convenient testing and easy reading of instruments. Control box is connected to panel with flexible cable and plug.

Seven large 5½ inch instruments with long legible scales.

Capacity readings of .1 to 15 microfarads on 1.5 and 15 microfarad scales.

Readings of plate current, as well as plate, grid, and filament voltages simultaneously. Provides tests for all tubes, including screen grid under actual operating conditions.

Continuity tests are read on a double range ohmmeter.

Mail coupon for complete description of the Pattern 579.

**No. 199 Set Analyzer**



The Jewell Pattern 199 Set Analyzer is the most popular set analyzer on the market because it—

Makes every practical radio field service test, including screen grid sets.

Is simple to operate—does not require a radio engineer to use it.

Is built to the highest standards throughout, and can be relied upon for accuracy as well as ability to stand the hard usage incurred in radio field service.

Is endorsed by leading radio engineers.

Is built throughout by manufacturers whose only business is the manufacture of precision instruments. Has push button switches that select desired scales in test service, eliminating troublesome rotary switches.

Is backed by a complete radio data service.

Is the lowest priced complete set analyzer on the market.

List price . . . . . \$97.50  
Dealers' price . . . . . 73.12

**No. 41 Ohmmeter**



Here is an instrument that makes it easy to check radio resistors quickly and accurately. The Jewell Pattern 41 Ohmmeter is a high grade D. C. instrument with a sub-base carrying a three-cell battery. Current drawn from the battery is very low and with ordinary use the battery lasts several months. It can be replaced conveniently.

A knurled knob provides adjustment for battery voltage variation through a magnetic shunt. In service the binding posts are short circuited before using and the pointer adjusted to the top of the scale. This corrects the instrument to the exact battery voltage, and resistance placed across the binding posts is accurately indicated in ohms direct on the scale. Construction of the Pattern 41 is rugged; the movement is of proven reliability and accuracy; it is an instrument that every service man should have.

Write for bulletin.

**Jewell Set Analyzers quickly pay for themselves. Service men who do not have good instruments pay for them over and over again in wasted time, costly service and loss of business. For sale by leading radio jobbers.**



30 YEARS MAKING GOOD INSTRUMENTS  
**JEWELL**  
SET ANALYZERS

Jewell Electrical Instrument Company  
1642-K Walnut Street, Chicago

Please send by return mail your booklet "Instructions for Servicing Radio Receivers" and the new Jewell bulletin on Radio Service Instruments.

Name \_\_\_\_\_  
Address \_\_\_\_\_